

**Svea Solar Power
Saver Battery**

User Manual

Issue 01
Date 2023-11-31

**SVEA
SOLAR**

the sun is the limit

About This Document

Purpose

This document describes the Power Saver battery (also referred to as product, equipment or energy storage) in terms of its overview, application scenarios, installation and commissioning, system maintenance, and technical specifications. The Power Saver battery consists of a Power Saver-SKW-CO power control module and Power Saver-5-EO 5kW battery expansion modules.



Intended Audience

This document is intended for:

- Sales engineers
- System engineers
- Technical support engineers
- End users

Symbol Conventions

The symbols that may be found in this document are defined as follows.

Symbol	Description
	Indicates a hazard with a high level of risk which, if not avoided, will result in death or serious injury.
	Indicates a hazard with a medium level of risk which, if not avoided, could result in death or serious injury.
	Indicates a hazard with a low level of risk which, if not avoided, could result in minor or moderate injury.

Contents

About This Document	ii
1 Safety Information	1
1.1 Personal Safety	2
1.2 Electrical Safety	4
1.3 Environment Requirements.....	8
1.4 Mechanical Safety.....	11
1.5 Battery Safety.....	15
2 Product Introduction	21
2.1 Overview	21
2.2 Appearance	24
2.3 Label Description.....	26
2.4 Features	28
2.5 Working Mode	29
3 Transportation and Storage.....	31
3.1 Transportation Requirements	31
3.2 Storage Requirements.....	34
4 Application Scenarios and Settings	36
4.1 Grid-tied ESS.....	36
4.1.1 Grid-tied ESS Networking.....	36
4.1.2 Setting the Grid-tied ESS Mode	42
4.2 Grid-tied and Off-grid ESS	49
4.2.1 Grid-tied and Off-grid ESS Networking.....	49
4.2.2 Setting the Grid-tied and Off-grid ESS Mode	56
4.3 Pure Off-grid ESS.....	58
4.3.1 Pure Off-grid ESS Networking	58
4.3.2 Setting the Pure Off-grid ESS Mode.....	59
4.4 Networking with Third-party Inverters	60
5 System Installation	66
5.1 Checking Before the Installation.....	67
5.2 Preparing Tools and Instruments.....	68
5.3 Determining the Installation Position	70

5.4 Equipment Installation	70
5.4.1 Floor-Mounted Installation	70
5.4.2 Wall-Mounted Installation	75
6 Electrical Connection	79
6.1 Preparing Cables	80
6.2 Internal Electrical Connections of the Battery	82
6.2.1 Installing an Internal Ground Cable	82
6.2.2 Installing Internal DC Terminals	83
6.2.3 Connecting Internal Signal Cables	85
6.3 External Electrical Connections of the Battery	86
6.3.1 Installing a PE Cable	89
6.3.2 Installing DC Input Power Cables	91
6.3.3 Installing a Signal Cable	92
6.4 (Optional) Cascading Batteries	95
6.5 Installing the Cover	97
7 System Commissioning	99
7.1 Verification Before Power-On	99
7.2 System Power-On	100
7.3 Battery Commissioning	101
7.3.1 Battery Deployment	102
7.3.2 Battery Control	108
7.3.3 Querying the Battery Status	113
7.3.4 Battery Maintenance and Upgrade	115
8 System Maintenance	118
8.1 System Power-Off	119
8.2 Routine Maintenance	119
8.3 Troubleshooting	120
8.4 Battery Storage and Recharge	131
8.5 Recharge Requirements for Batteries with a Low SOC	136
8.6 Battery SOH Check	137
9 Emergency Handling	140
10 Technical Specifications	145
10.1 Power Saver-5KW-C0	145
10.2 Power Saver-5-E0	146
10.3 Power Saver-Related	146
11 FAQs	148
11.1 How Do I Replace a Fuse?	148
11.2 SOC Change Description	150
11.3 Checking Cable Connection when the Battery Fails to Be Upgraded	150
11.4 Delayed Upgrade Description	150
11.5 How Do I Recycle Used Batteries?	151

A Acronyms and Abbreviations..... 152

1 Safety Information

Statement

Before transporting, storing, installing, operating, using, and/or maintaining the equipment, read this document, strictly follow the instructions provided herein, and follow all the safety instructions on the equipment and in this document. In this document, "equipment" refers to the products, software, components, spare parts, and/or services related to this document; "the Company" refers to the manufacturer (producer), seller, and/or service provider of the equipment; "you" refers to the entity that transports, stores, installs, operates, uses, and/or maintains the equipment.

The **Danger, Warning, Caution, and Notice** statements described in this document do not cover all the safety precautions. You also need to comply with relevant international, national, or regional standards and industry practices. **The Company shall not be liable for any consequences that may arise due to violations of safety requirements or safety standards concerning the design, production, and usage of the equipment.**

The equipment should be used in an environment that meets the design specifications. Otherwise, the equipment may be faulty, malfunctioning, or damaged, which is not covered under the warranty. The Company shall not be liable for any property loss, personal injury, or even death caused thereby.

Comply with applicable laws, regulations, standards, and specifications during transportation, storage, installation, operation, use, and maintenance.

Do not perform reverse engineering, decompilation, disassembly, adaptation, implantation, or other derivative operations on the equipment software. Do not study the internal implementation logic of the equipment, obtain the source code of the equipment software, violate intellectual property rights, or disclose any of the performance test results of the equipment software.

The Company shall not be liable for any of the following circumstances or their consequences:

- The equipment is damaged due to force majeure such as earthquakes, floods, volcanic eruptions, debris flows, lightning strikes, fires, wars, armed conflicts, typhoons, hurricanes, tornadoes, and other extreme weather conditions.
 - The equipment is operated beyond the conditions specified in this document.
-

- The equipment is installed or used in environments that do not comply with international, national, or regional standards.
- The equipment is installed or used by unqualified personnel.
- You fail to follow the operation instructions and safety precautions on the product and in the document.
- You remove or modify the product or modify the software code without authorization.
- You or a third party authorized by you cause the equipment damage during transportation.
- The equipment is damaged due to storage conditions that do not meet the requirements specified in the product document.
- You fail to prepare materials and tools that comply with local laws, regulations, and related standards.
- The equipment is damaged due to your or a third party's negligence, intentional breach, gross negligence, or improper operations, or other reasons not related to the Company.

1.1 Personal Safety

ffi DANGER

Ensure that power is off during installation. Do not install or remove a cable with power on. Transient contact between the core of the cable and the conductor will cause electric arcs, sparks, fire, or explosion, which may result in personal injury.

ffi DANGER

Non-standard and improper operations on the energized equipment may cause fire, electric shocks, or explosion, resulting in property damage, personal injury, or even death.

ffi DANGER

Before operations, remove conductive objects such as watches, bracelets, bangles, rings, and necklaces to prevent electric shocks.

ffi DANGER

During operations, use dedicated insulated tools to prevent electric shocks or short circuits. The dielectric withstanding voltage level must comply with local laws, regulations, standards, and specifications.

A. DANGER

During operations, wear personal protective equipment such as protective clothing, insulated shoes, goggles, safety helmets, and insulated gloves.

Figure 1-1 Personal protective equipment



General Requirements

- Do not stop protective devices. Pay attention to the warnings, cautions, and related precautionary measures in this document and on the equipment.
- If there is a likelihood of personal injury or equipment damage during operations, immediately stop, report the case to the supervisor, and take feasible protective measures.
- Do not power on the equipment before it is installed or confirmed by professionals.
- Do not touch the power supply equipment directly or with conductors such as damp objects. Before touching any conductor surface or terminal, measure the voltage at the contact point to ensure that there is no risk of electric shock.
- Do not touch operating equipment because the enclosure is hot.
- In the case of a fire, immediately leave the building or the equipment area and activate the fire alarm or call emergency services. Do not enter the affected building or equipment area under any circumstances.

Personnel Requirements

- Only professionals and trained personnel are allowed to operate the equipment.
 - Professionals: personnel who are familiar with the working principles and structure of the equipment, trained or experienced in equipment operations and are clear of the sources and degree of various potential hazards in equipment installation, operation, maintenance
 - Trained personnel: personnel who are trained in technology and safety, have required experience, are aware of possible hazards on themselves in

certain operations, and are able to take protective measures to minimize the hazards on themselves and other people

- Personnel who plan to install or maintain the equipment must receive adequate training, be able to correctly perform all operations, and understand all necessary safety precautions and local relevant standards.
- Only qualified professionals or trained personnel are allowed to install, operate, and maintain the equipment.
- Only qualified professionals are allowed to remove safety facilities and inspect the equipment.
- Personnel who will perform special tasks such as electrical operations, working at heights, and operations of special equipment must possess the required local qualifications.
- Only authorized professionals are allowed to replace the equipment or components (including software).
- Only personnel who need to work on the equipment are allowed to access the equipment.

1.2 Electrical Safety

DANGER

Before connecting cables, ensure that the equipment is intact. Otherwise, electric shocks or fire may occur.

ffi DANGER

Non-standard and improper operations may result in fire or electric shocks.

ffi DANGER

Prevent foreign matter from entering the equipment during operations. Otherwise, equipment damage, load power derating, power failure, or personal injury may occur.

ffi WARNING

For the equipment that needs to be grounded, install the ground cable first when installing the equipment and remove the ground cable last when removing the equipment.

General Requirements

- Follow the procedures described in the document for installation, operation, and maintenance. Do not reconstruct or alter the equipment, add components, or change the installation sequence without permission.
- Obtain approval from the national or local electric utility company before connecting the equipment to the grid.
- Observe the power plant safety regulations, such as the operation and work ticket mechanisms.
- Install temporary fences or warning ropes and hang "No Entry" signs around the operation area to keep unauthorized personnel away from the area.
- Before installing or removing power cables, turn off the switches of the equipment and its upstream and downstream switches.
- If any liquid is detected inside the equipment, disconnect the power supply immediately and do not use the equipment.
- Before performing operations on the equipment, check that all tools meet the requirements and record the tools. After the operations are complete, collect all of the tools to prevent them from being left inside the equipment.
- Before installing power cables, check that cable labels are correct and cable terminals are insulated.
- When installing the equipment, use a torque tool of a proper measurement range to tighten the screws. When using a wrench to tighten the screws, ensure that the wrench does not tilt and the torque error does not exceed 10% of the specified value.
- Ensure that bolts are tightened with a torque tool and marked in red and blue after double-check. Installation personnel mark tightened bolts in blue. Quality inspection personnel confirm that the bolts are tightened and then mark them in red. (The marks should cross the edges of the bolts.)

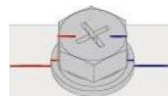

CZ0000112

- After the installation is complete, ensure that protective cases, insulation tubes, and other necessary items for all electrical components are in position to avoid electric shocks.
- If the equipment has multiple inputs, disconnect all the inputs before operating the equipment.
- Before maintaining a downstream electrical or power distribution device, turn off the output switch on the power supply equipment.
- During equipment maintenance, attach "Do not switch on" labels near the upstream and downstream switches or circuit breakers as well as warning signs to prevent accidental connection. The equipment can be powered on only after troubleshooting is complete.
- If fault diagnosis and troubleshooting need to be performed after power-off, take the following safety measures: Disconnect the power supply. Check whether the equipment is live. Install a ground cable. Hang warning signs and set up fences.
- Do not open equipment panels.

- Check equipment connections periodically, ensuring that all screws are securely tightened.
- Only qualified professionals can replace a damaged cable.
- Do not scrawl, damage, or block any labels or nameplates on the equipment. Promptly replace labels that have worn out.
- Do not use solvents such as water, alcohol, or oil to clean electrical components inside or outside of the equipment.

Grounding

- Ensure that the grounding impedance of the equipment complies with local electrical standards.
- Ensure that the equipment is connected permanently to the protective ground. Before operating the equipment, check its electrical connection to ensure that it is reliably grounded.
- Do not work on the equipment in the absence of a properly installed ground conductor.
- Do not damage the ground conductor.
- For the equipment that uses a three-pin socket, ensure that the ground terminal in the socket is connected to the protective ground point.
- If high touch current may occur on the equipment, ground the protective ground terminal on the equipment enclosure before connecting the power supply; otherwise, electric shock as a result of touch current may occur.

Cabling Requirements

- When selecting, installing, and routing cables, follow local safety regulations and rules.
- When routing power cables, ensure that there is no coiling or twisting. Do not join or weld power cables. If necessary, use a longer cable.
- Ensure that all cables are properly connected and insulated, and meet specifications.
- Ensure that the slots and holes for routing cables are free from sharp edges, and that the positions where cables are routed through pipes or cable holes are equipped with cushion materials to prevent the cables from being damaged by sharp edges or burrs.
- Ensure that cables of the same type are bound together neatly and straight and that the cable sheath is intact. When routing cables of different types, ensure that they are away from each other without entanglement and overlapping.
- When cable connection is completed or paused for a short period of time, seal the cable holes with sealing putty immediately to prevent small animals or moisture from entering.
- Secure buried cables using cable supports and cable clips. Ensure that the cables in the backfill area are in close contact with the ground to prevent cable deformation or damage during backfilling.
- If the external conditions (such as the cable layout or ambient temperature) change, verify the cable usage in accordance with the IEC-60364-5-52 or local laws and regulations. For example, check that the current-carrying capacity meets requirements.

- When routing cables, reserve at least 30 mm clearance between the cables and heat-generating components or areas. This prevents deterioration or damage to the cable insulation layer.
- When the temperature is low, violent impact or vibration may damage the plastic cable sheathing. To ensure safety, comply with the following requirements:
 - Cables can be laid or installed only when the temperature is higher than 0°C. Handle cables with caution, especially at a low temperature.
 - Cables stored at subzero temperatures must be stored at room temperature for at least 24 hours before they are laid out.
- Do not perform any improper operations, for example, dropping cables directly from a vehicle. Otherwise, the cable performance may deteriorate due to cable damage, which affects the current-carrying capacity and temperature rise.

ESD

NOTICE

The static electricity generated by human bodies may damage the electrostatic-sensitive components on boards, for example, the large-scale integrated (LSI) circuits.

- When touching the equipment and handling boards, modules with exposed circuit boards, or application-specific integrated circuits (ASICs), observe ESD protection regulations and wear ESD clothing and ESD gloves or a well-grounded ESD wrist strap.

Figure 1-2 Wearing an ESD wrist strap

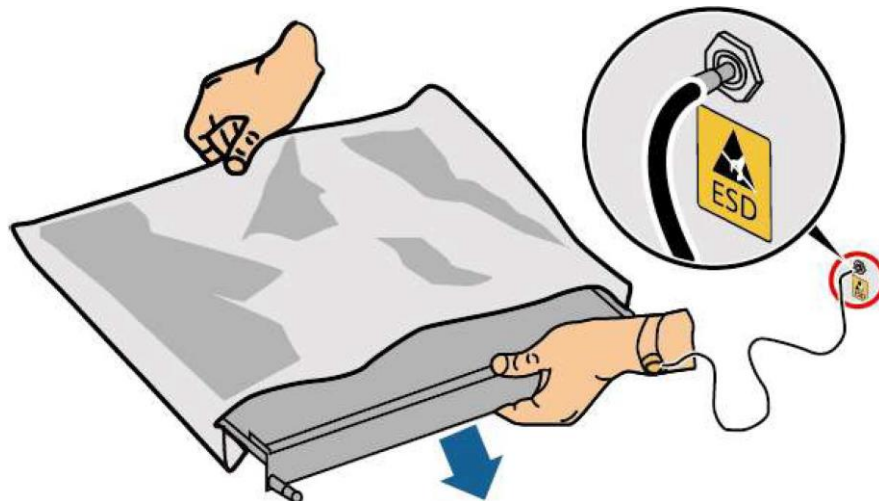

DC15000001

- When holding a board or a module with exposed circuit boards, hold its edge without touching any components. Do not touch the components with bare hands.

- Package boards or modules with ESD packaging materials before storing or transporting them.

1.3 Environment Requirements

***Lt*, DANGER**

Do not expose the equipment to flammable or explosive gas or smoke. Do not perform any operation on the equipment in such environments.

***Lt*, DANGER**

Do not store any flammable or explosive materials in the equipment area.

***Lt*, DANGER**

Do not place the equipment near heat sources or fire sources, such as smoke, candles, heaters, or other heating devices. Overheat may damage the equipment or cause a fire.

***ffi* WARNING**

Install the equipment in an area far away from liquids. Do not install it under areas prone to condensation, such as under water pipes and air exhaust vents, or areas prone to water leakage, such as air conditioner vents, ventilation vents, or feeder windows of the equipment room. Ensure that no liquid enters the equipment to prevent faults or short circuits.

***ffi* WARNING**

To prevent damage or fire due to high temperature, ensure that the ventilation vents or heat dissipation systems are not obstructed or covered by other objects while the equipment is running.

General Requirements

- The installation and usage environment must meet relevant international, national, and local standards for lithium batteries, and are in accordance with the local laws and regulations. The user is obliged to protect the ESS against fire or other hazards.
- Keep the ESS out of the reach of children and away from daily working or living areas, including but not limited to the following areas: studio, bedroom, lounge, living room, music room, kitchen, study, game room, home theater, sunroom, toilet, bathroom, laundry, and attic.

- When installing the ESS in a garage, keep it clear of the drive path. It is recommended that the ESS be mounted on the wall higher than the bumper to prevent collision.
- Do not install the ESS in places that are enclosed, unventilated, without proper fire fighting facilities, or difficult for firefighters to access. Do not place flammable or explosive materials around the ESS. It is recommended that the ESS be mounted on a wall to avoid contact with water.
- Install the ESS in a sheltered place or install an awning over it to avoid direct sunlight or rain.
- For areas prone to natural disasters such as floods, debris flows, earthquakes, and typhoons, take corresponding precautions for installation.
- Do not install the ESS in an easily accessible position because the temperature of the enclosure and heat sink is high when the ESS is running.
- Do not install the ESS on a moving object, such as ship, train, or car.
- Ensure that the equipment is stored in a clean, dry, and well ventilated area with proper temperature and humidity and is protected from dust and condensation.
- Keep the installation and operating environments of the equipment within the allowed ranges. Otherwise, its performance and safety will be compromised.
- Do not install, use, or operate outdoor equipment and cables (including but not limited to moving equipment, operating equipment and cables, inserting connectors to or removing connectors from signal ports connected to outdoor facilities, working at heights, performing outdoor installation, and opening doors) in harsh weather conditions such as lightning, rain, snow, and level 6 or stronger wind.
- Do not install the equipment in an environment with direct sunlight, dust, smoke, volatile or corrosive gases, infrared and other radiations, organic solvents, or salty air.
- Do not install the equipment in an environment with conductive metal or magnetic dust.
- Do not install the equipment in an area conducive to the growth of microorganisms such as fungus or mildew.
- Do not install the equipment in an area with strong vibration, noise, or electromagnetic interference.
- Ensure that the site complies with local laws, regulations, and related standards.
- Ensure that the ground in the installation environment is solid, free from spongy or soft soil, and not prone to subsidence. The site must not be located in a low-lying land prone to water or snow accumulation, and the horizontal level of the site must be above the highest water level of that area in history.
- Do not install the equipment in a position that may be submerged in water.
- If the equipment is installed in a place with abundant vegetation, in addition to routine weeding, harden the ground underneath the equipment using cement or gravel.
- Do not install the equipment outdoors in salt-affected areas because it may be corroded. A salt-affected area refers to the region within 500 m of the coast or prone to sea breeze. Regions prone to sea breeze vary with weather

conditions (such as typhoons and monsoons) or terrains (such as dams and hills).

- Before installation, operation, and maintenance, clean up any water, ice, snow, or other foreign objects on the top of the equipment.
- When installing the equipment, ensure that the installation surface is solid enough to bear the weight of the equipment.
- After installing the equipment, remove the packing materials such as cartons, foam, plastics, and cable ties from the equipment area.

Figure 1-3 Installation environment

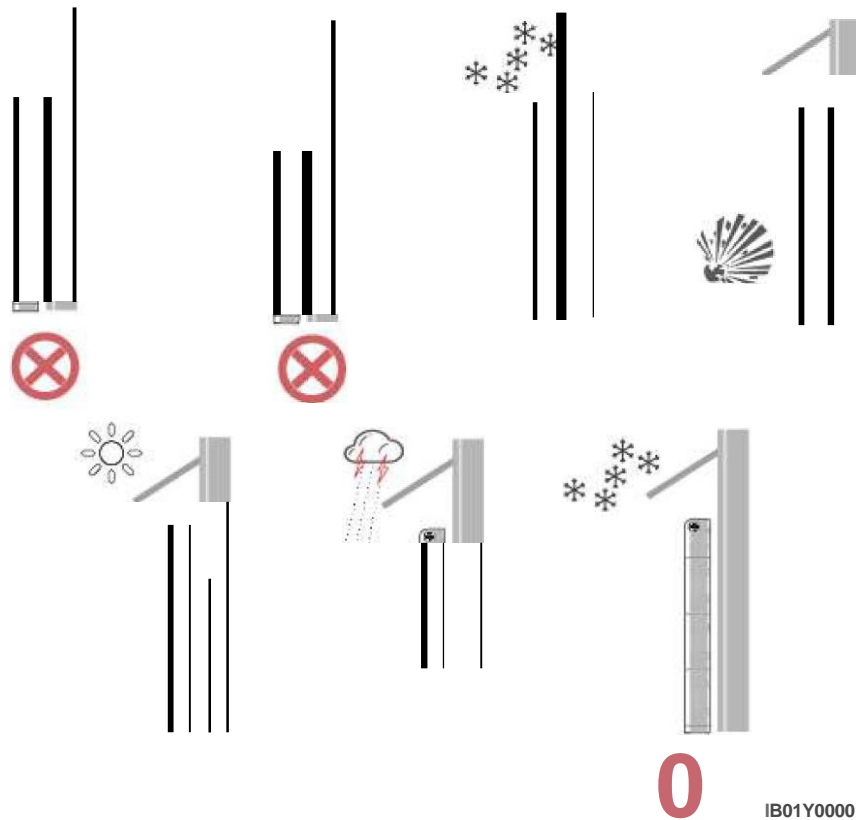

[O NOTE]

- The operation and service life of the battery depend on the operating temperature. Install the battery at a temperature equal to the ambient temperature or in a better environment.
- The operating temperature of the Power Saver ranges from -20°C to +55°C. If the Power Saver is installed in a cold environment, the built-in thermal control system starts to heat the battery to achieve better performance. The heating process consumes rechargeable power, which reduces the system energy efficiency in cold weather.
- If the Power Saver is stored in a cold environment (for example, 0°C) before installation, the Power Saver needs some time (< 2 h) to heat up before it can be charged. You are advised to place the Power Saver in a warm place before installation to facilitate commissioning.
- When the ambient temperature of the Power Saver is higher than +45°C or lower than -10°C, the battery charge and discharge power will be derated.

1.4 Mechanical Safety

DANGER

When working at heights, wear a safety helmet and safety harness or waist belt and fasten it to a solid structure. Do not mount it on an insecure moveable object or metal object with sharp edges. Make sure that the hooks will not slide off.

ffi WARNING

Ensure that all necessary tools are ready and inspected by a professional organization. Do not use tools that have signs of scratches or fail to pass the inspection or whose inspection validity period has expired. Ensure that the tools are secure and not overloaded.

ffi WARNING

Do not drill holes into the equipment. Doing so may affect the sealing performance and electromagnetic containment of the equipment and damage components or cables inside. Metal shavings from drilling may short-circuit boards inside the equipment.

General Requirements

- Repaint any paint scratches caused during equipment transportation or installation in a timely manner. Equipment with scratches cannot be exposed for an extended period of time.
- Do not perform operations such as arc welding and cutting on the equipment without evaluation by the Company.
- Do not install other devices on the top of the equipment without evaluation by the Company.

- When performing operations over the top of the equipment, take measures to protect the equipment against damage.
- Use correct tools and operate them in the correct way.

Moving Heavy Objects

- If multiple persons need to move a heavy object together, determine the manpower and work division with consideration of height and other conditions to ensure that the weight is equally distributed.
- If two persons or more move a heavy object together, ensure that the object is lifted and landed simultaneously and moved at a uniform pace under the supervision of one person.
- Wear personal protective gears such as protective gloves and shoes when manually moving the equipment.
- To move an object by hand, approach to the object, squat down, and then lift the object gently and stably by the force of the legs instead of your back. Do not lift it suddenly or turn your body around.
- Do not quickly lift a heavy object above your waist. Place the object on a workbench that is half-waist high or any other appropriate place, adjust the positions of your palms, and then lift it.
- Move a heavy object stably with balanced force at an even and low speed. Put down the object stably and slowly to prevent any collision or drop from scratching the surface of the equipment or damaging the components and cables.
- When moving a heavy object, be aware of the workbench, slope, staircase, and slippery places. When moving a heavy object through a door, ensure that the door is wide enough to move the object and avoid bumping or injury.
- When transferring a heavy object, move your feet instead of turning your waist around. When lifting and transferring a heavy object, ensure that your feet point to the target direction of movement.
- When transporting the equipment using a pallet truck or forklift, ensure that the tynes are properly positioned so that the equipment does not topple. Before moving the equipment, secure it to the pallet truck or forklift using ropes. When moving the equipment, assign dedicated personnel to take care of it.
- Choose sea or roads in good conditions for transportation as transportation by railway or air is not supported. Avoid tilt or jolt during transportation.

Working at Heights

- Any operations performed 2 meters or higher above the ground should be supervised properly.

- Only trained and qualified personnel are allowed to work at heights.
- Do not work at heights when steel pipes are wet or other risky situations exist. After the preceding conditions no longer exist, the safety owner and relevant technical personnel need to check the involved equipment. Operators can begin working only after safety is confirmed.
- Set a restricted area and prominent signs for working at heights to warn away irrelevant personnel.
- Set guard rails and warning signs at the edges and openings of the area involving working at heights to prevent falls.
- Do not pile up scaffolding, springboards, or other objects on the ground under the area involving working at heights. Do not allow people to stay or pass under the area involving working at heights.
- Carry operation machines and tools properly to prevent equipment damage or personal injury caused by falling objects.
- Personnel involving working at heights are not allowed to throw objects from the height to the ground, or vice versa. Objects should be transported by slings, hanging baskets, highline trolleys, or cranes.
- Do not perform operations on the upper and lower layers at the same time. If unavoidable, install a dedicated protective shelter between the upper and lower layers or take other protective measures. Do not pile up tools or materials on the upper layer.
- Dismantle the scaffolding from top down after finishing the job. Do not dismantle the upper and lower layers at the same time. When removing a part, ensure that other parts will not collapse.
- Ensure that personnel working at heights strictly comply with the safety regulations. The Company is not responsible for any accident caused by violation of the safety regulations on working at heights.
- Behave cautiously when working at heights. Do not rest at heights.

Using Ladders

- Use wooden or insulated ladders when you need to perform live-line working at heights.
- Platform ladders with protective rails are preferred. Single ladders are not recommended.
- Before using a ladder, check that it is intact and confirm its load bearing capacity. Do not overload it.
- Ensure that the ladder is securely positioned and held firm.



CZ00000107

- When climbing up the ladder, keep your body stable and your center of gravity between the side rails, and do not overreach to the sides.
- When a step ladder is used, ensure that the pull ropes are secured.
- If a single ladder is used, the recommended angle for the ladder against the floor is 75 degrees, as shown in the following figure. A square can be used to measure the angle.

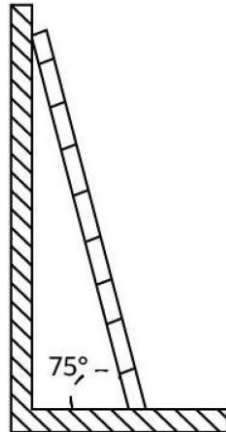

PI02SC0008

- If a single ladder is used, ensure that the wider end of the ladder is at the bottom, and take protective measures to prevent the ladder from sliding.
- If a single ladder is used, do not climb higher than the fourth rung of the ladder from the top.
- If you use a single ladder to climb up to a platform, ensure that the ladder is at least 1 m higher than the platform.

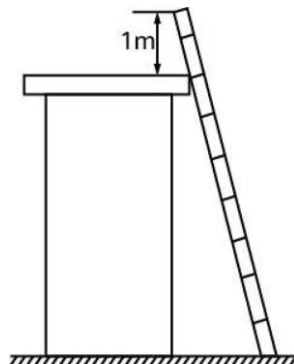

PI02SC0009

Drilling Holes

- Obtain consent from the customer and contractor before drilling holes.
- Wear protective equipment such as safety goggles and protective gloves when drilling holes.
- To avoid short circuits or other risks, do not drill holes into buried pipes or cables.
- When drilling holes, protect the equipment from shavings. After drilling, clean up any shavings.

1.5 Battery Safety

ffi DANGER

Do not connect the positive and negative poles of a battery together. Otherwise, the battery may be short-circuited. Battery short circuits can generate high instantaneous current and releases a large amount of energy, which may cause battery leakage, smoke, flammable gas release, thermal runaway, fire, or explosion. To avoid battery short circuits, do not maintain batteries with power on.

ffi DANGER

Do not expose batteries at high temperatures or around heat sources, such as scorching sunlight, fire sources, transformers, and heaters. Battery overheating may cause leakage, smoke, flammable gas release, thermal runaway, fire, or explosion.

ffi DANGER

Protect batteries from mechanical vibration, falling, collision, punctures, and strong impact. Otherwise, the batteries may be damaged or catch fire.

ffi DANGER

To avoid leakage, smoke, flammable gas release, thermal runaway, fire, or explosion, do not disassemble, alter, or damage batteries, for example, insert foreign objects into batteries, squeeze batteries, or immerse batteries in water or other liquids.

ffi DANGER

Do not touch battery terminals with other metal objects, which may cause heat or electrolyte leakage.

ffi DANGER

There is a risk of fire or explosion if the model of the battery in use or used for replacement is incorrect. Use a battery of the model recommended by the manufacturer.

DANGER

Battery electrolyte is toxic and volatile. Do not get contact with leaked liquids or inhale gases in the case of battery leakage or odor. In such cases, stay away from the battery and contact professionals immediately. Professionals must wear safety goggles, rubber gloves, gas masks, and protective clothing, power off the equipment, remove the battery, and contact technical engineers.

ffi DANGER

A battery is an enclosed system and will not release any gases under normal operations. If a battery is improperly treated, for example, burnt, needle-pricked, squeezed, struck by lightning, overcharged, or subject to other adverse conditions that may cause battery thermal runaway, the battery may be damaged or an abnormal chemical reaction may occur inside the battery, resulting in electrolyte leakage or production of gases such as CO and H₂. To prevent fire or device corrosion, ensure that flammable gas is properly exhausted.

ffi DANGER

The gas generated by a burning battery may irritate your eyes, skin, and throat. Take protective measures promptly.

ffi WARNING

Install batteries in a dry area. Do not install them under areas prone to water leakage, such as air conditioner vents, ventilation vents, feeder windows of the equipment room, or water pipes. Ensure that no liquid enters the equipment to prevent faults or short circuits.

ffi WARNING

Before unpacking, storage, and transportation, ensure that the packing cases are intact and the batteries are correctly placed according to the labels on the packing cases. Do not place a battery upside down or vertically, lay it on one side, or tilt it. Stack the batteries according to the stacking requirements on the packing cases. Ensure that the batteries do not fall or get damaged. Otherwise, they will need to be scrapped.

ffi WARNING

After unpacking batteries, place them in the required direction. Do not place a battery upside down or vertically, lay it on one side, tilt it, or stack it. Ensure that the batteries do not fall or get damaged. Otherwise, they will need to be scrapped.

Lt_ WARNING

Tighten the screws on copper bars or cables to the torque specified in this document. Periodically confirm whether the screws are tightened, check for rust, corrosion, or other foreign objects, and clean them up if any. Loose screw connections will result in excessive voltage drops and batteries may catch fire when the current is high.

Lt_ WARNING

After batteries are discharged, charge them in time to avoid damage due to overdischarge.

Statement

The Company shall not be liable for any damage or other consequences to the batteries it provides due to the following reasons:

- Batteries are damaged due to force majeure such as earthquakes, floods, volcanic eruptions, debris flows, lightning strikes, fires, wars, armed conflicts, typhoons, hurricanes, tornadoes, and other extreme weather conditions.
- Batteries are damaged because the onsite equipment operating environment or external power parameters do not meet the environment requirements for normal operation, for example, the actual operating temperature of batteries is too high or too low, or the power grid is unstable and experiences outages frequently.
- Batteries are damaged, fall, leak, or crack due to improper operations or incorrect connection.
- After being installed and connected to the system, the batteries are not powered on in time due to your reasons, which causes damage to the batteries due to overdischarge.
- Batteries are damaged because they are not accepted in time due to your reasons.
- You set battery operating parameters incorrectly.
- You use batteries of different types together, causing acceleration of capacity attenuation. For example, you use our batteries together with batteries of other vendors or with batteries of different rated capacity.
- You maintain batteries improperly, causing frequent overdischarge; you expand the load capacity without notifying us; or you have not fully charged the batteries for a long time.
- You do not perform battery maintenance based on the operation guide, such as failure to check battery terminals regularly.
- Batteries are damaged because you do not store them in accordance with storage requirements (for example, in an environment that is damp or prone to rain).
- Batteries are not charged as required during storage due to your reasons, resulting in capacity loss or other irreversible damages to the batteries.

- Batteries are damaged due to your or a third party's reasons, for example, relocating or reinstalling the batteries without complying with the Company's requirements.
- You change the battery use scenarios without notifying the Company.
- You connect extra loads to the batteries.
- The battery storage period has exceeded the upper limit.
- The battery warranty period has expired. Do not use a battery whose warranty period has expired, as this poses safety risks.

General Requirements

NOTICE

To ensure battery safety and battery management accuracy, use batteries provided by the Company. The Company is not responsible for any faults of batteries not provided by it.

- Before installing, operating, and maintaining batteries, read the battery manufacturer's instructions and comply with their requirements. The safety precautions specified in this document are highly important and require special attention. For additional safety precautions, see the instructions provided by the battery manufacturer.
- Use batteries within the specified temperature range. When the ambient temperature of the batteries is lower than the allowed range, do not charge the batteries to prevent internal short circuits caused during low-temperature charging.
- Before unpacking batteries, check whether the packaging is intact. Do not use batteries with damaged packaging. If any damage is found, notify the carrier and manufacturer immediately.
- Power on batteries within 24 hours after unpacking. If the batteries cannot be powered on in time, put them in the original packaging and place them in a dry indoor environment without corrosive gases. During later maintenance, ensure that the power-off time does not exceed 24 hours.
- Do not use a damaged battery (such as damage caused when a battery is dropped, bumped, bulged, or dented on the enclosure), because the damage may cause electrolyte leakage or flammable gas release. In the case of electrolyte leakage or structural deformation, contact the installer or professional O&M personnel immediately to remove or replace the battery. Do not store the damaged battery near other devices or flammable materials and keep it away from non-professionals.
- Before working on a battery, ensure that there is no irritant or scorched smell around the battery.
- When installing batteries, do not place installation tools, metal parts, or sundries on the batteries. After the installation is complete, clean up the objects on the batteries and the surrounding area.
- If batteries are exposed to water accidentally, do not install them. Instead, transport the batteries to a safe isolation point and dispose of them in a timely manner.

- Before installing battery packs, check whether they are abnormal. A battery pack is deemed abnormal when any of the following symptoms occurs:
 - The enclosure of the battery pack is obviously deformed or damaged.
 - The voltage between the positive and negative electrodes of the battery pack is far below the specified range.
- Check whether the positive and negative battery terminals are grounded unexpectedly. If so, disconnect the battery terminals from the ground.
- Do not perform welding or grinding work around batteries to prevent fire caused by electric sparks or arcs.
- If batteries are left unused for a long period of time, store and charge them according to the battery requirements.
- Do not charge or discharge batteries by using a device that does not comply with local laws and regulations.
- Keep the battery loop disconnected during installation and maintenance.
- Monitor damaged batteries during storage for signs of smoke, flame, electrolyte leakage, or heat.
- If a battery is faulty, its surface temperature may be high. Do not touch the battery to avoid scalds.
- Do not stand on, lean on, or sit on the top of the equipment.
- In backup power scenarios, do not use the batteries for the following situations:
 - Medical devices substantially important to human life
 - Control equipment such as trains and elevators, as this may cause personal injury
 - Computer systems of social and public importance
 - Locations near medical devices
 - Other devices similar to those described above

Short-Circuit Protection

- When installing and maintaining batteries, wrap the exposed cable terminals on the batteries with insulation tape.
- Avoid foreign objects (such as conductive objects, screws, and liquids) from entering a battery, as this may cause short circuits.

Recycling

- Dispose of waste batteries in accordance with local laws and regulations. Do not dispose of batteries as household waste. Improper disposal of batteries may result in environmental pollution or an explosion.
- If a battery leaks or is damaged, contact technical support or a battery recycling company for disposal.
- If batteries are out of service life, contact a battery recycling company for disposal.
- Do not expose waste batteries to high temperatures or direct sunlight.
- Do not place waste batteries in environments with high humidity or corrosive substances.

- Do not use faulty batteries. Contact a battery recycling company to scrap them as soon as possible to avoid environmental pollution.

2 Product Introduction

2.1 Overview

Function

The Power Saver battery consists of a power control module and battery expansion modules. It can store and release electric energy based on the requirements of the inverter management system. The input and output ports of the Power Saver battery are high-voltage direct current (HVDC) ports.

- Battery charge: The power control module connects to the battery terminals (BAT+ and BAT-) of the inverter. Under the control of the inverter, the power control module charges the batteries and stores excessive PV energy in batteries.
- Battery discharge: When the PV energy is insufficient to supply power to the loads, the system controls the batteries to supply power to the loads. The battery energy is output to the loads through the inverter.

Model

- Model of the power control module in the Power Saver battery:
Power Saver-SKW-CO

Figure 2-1 Model number

Power Saver-5KW-C0

2 3

IB01W00001

Table 2-1 Model description

No.	Meaning	Value
1	Product	Power Saver battery
2	Power level	5KW: The power level is 5 kW.
3	Design code	CO: product series of the power control module

- Model of battery expansion modules in the Power Saver battery: Power Saver-5-E0

Figure 2-2 Model number

Svea Solar-5-E0

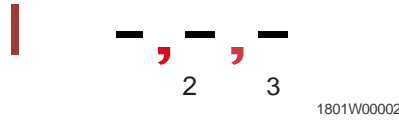

Table 2-2 Model description

No.	Meaning	Value
1	Product	Power Saver: residential battery
2	Energy level	5: The energy level is 5 kWh.
3	Design code	EO: battery pack module

- The model of the Power Saver battery is Power Saver-5-S0.

Figure 2-3 Model number

Svea Solar-5-S0

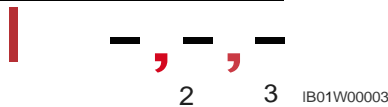

Table 2-3 Model description

No.	Meaning	Value
1	Product	Power Saver: residential battery
2	Energy level	5: The capacity level is 5 kWh. This product supports 5 kWh to 30 kWh.

No.	Meaning	Value
3	Design code	S0: battery

Battery Capacity Description

The battery supports power and capacity expansion. Two power control modules can be connected in parallel. One power control module supports a maximum of three battery expansion modules.

Figure 2-4 Battery capacity description

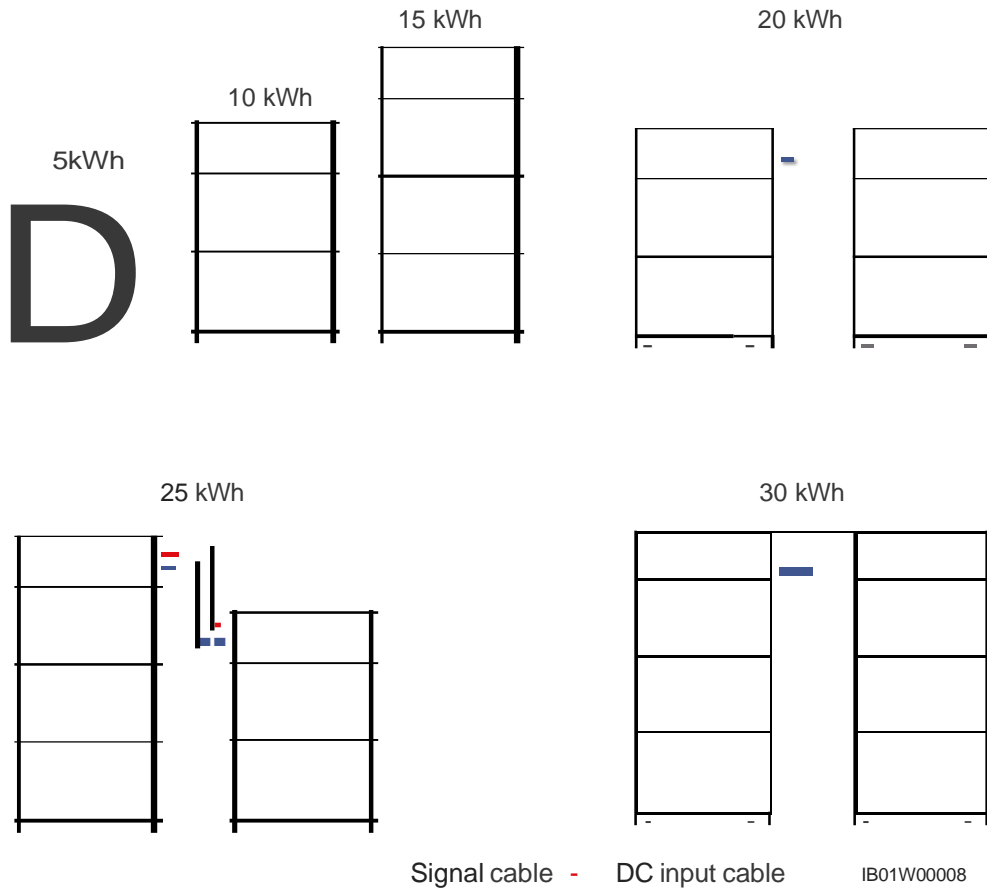

Networking Application

The Power Saver battery is applicable to the grid-tied systems of residential rooftop PV plants. Typically, a grid-tied system consists of PV strings, Power Saver batteries, Power Saver inverter, an AC switch, and a power distribution box (PDB).

Figure 2-5 Networking (dashed boxes indicate optional components)

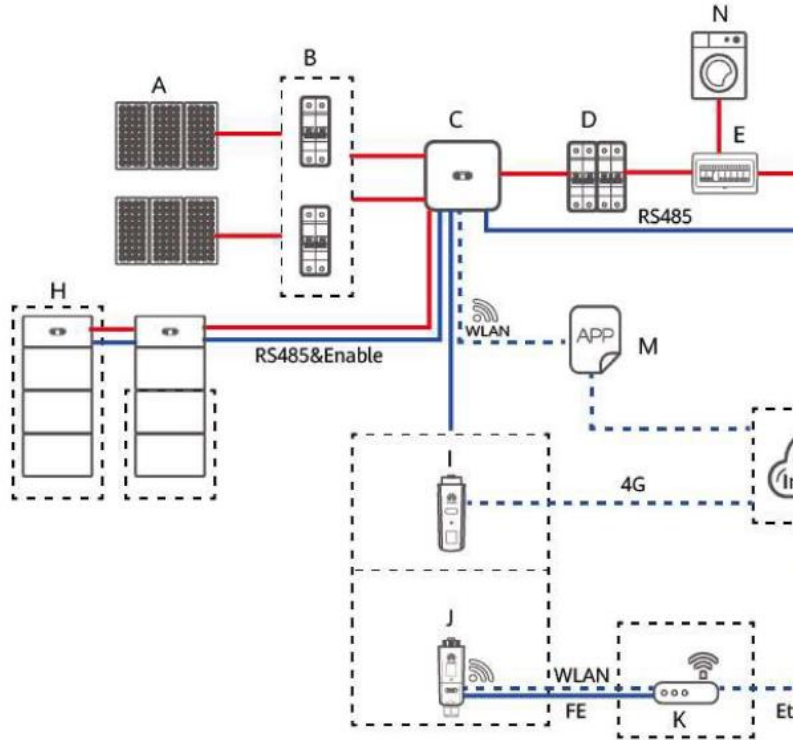

- | | | |
|--------------------------|-----------------|-----------------------------------|
| (A) PV string | (B) DC switch | (C) Power Shifter inverter |
| (D) AC switch | (E) AC/DC | (F) Smart Power Sensor |
| (G) Power grid | (H) Power Saver | (I) 4G Smart Dongle |
| (J) WLAN-FE Smart Dongle | (K) Router | (L) FusionSolar management system |
| (M) FusionSolar app | (N) Load | |

NOTE

- — indicates a power cable, — indicates a signal cable, *-----* indicates wireless communication.
- The input and output ports of the Power Saver battery are connected to the battery ports of the inverter.
- The following communication modes are supported by the Power Saver battery:
 - Connect the Power Saver battery to the inverter over the RS485 port and Enable port to implement communication and control between the inverter and the Power Saver battery.
 - Use the mobile phone App to directly connect to the inverter or connect to the inverter in the same LAN to manage and maintain the Power Saver battery.
 - Connect the inverter to the public network through the Smart Dongle to manage and maintain the Power Saver battery through the management system.

2.2 Appearance

Battery

This topic describes the battery appearance.

Figure 2-6 Battery appearance

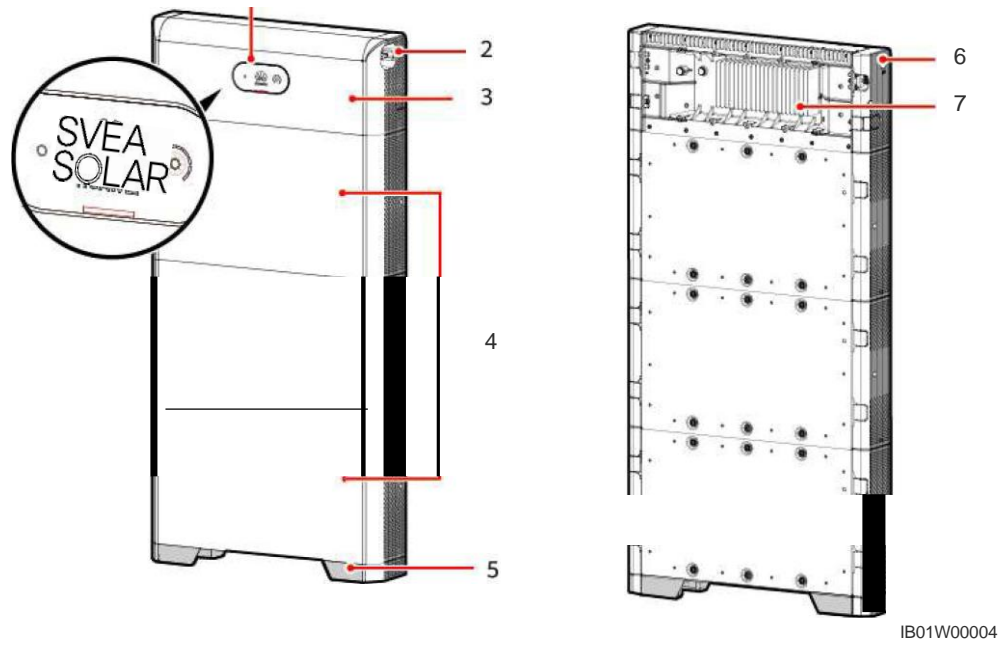

- (1) LED-indicator
- (2) DC switch
- (3) Power control module
- (4) Battery expansion modules
- (5) Installation base
- (6) Black start switch
- (7) Heat sink

Power Control Module

The power of the power control module is 5 kW.

Figure 2-7 Power control module

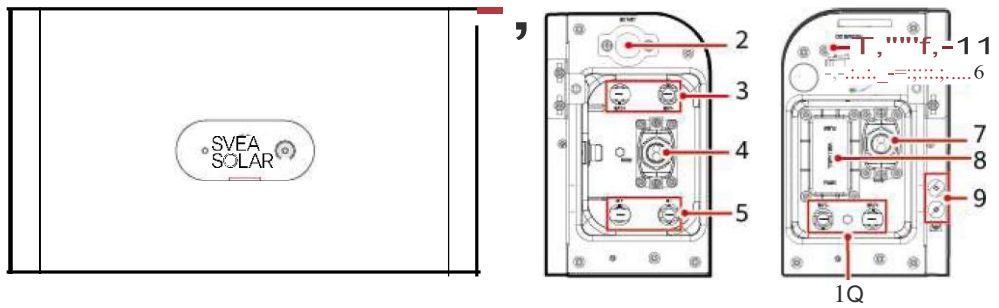

- | | | |
|------------------------------------|---|-----------------------------------|
| (1) Power control module | (2) Black start switch | (3) Battery terminals (BAT+/BAT-) |
| (4) COM port (COM) | (5) Battery cascading terminals (B+/B-) | (6) DC switch (DC SWITCH) |
| (7) COM port (COM) | (8) Fuse | (9) Ground point |
| (10) Battery terminals (BAT-/BAT+) | (11) Locking screw hole for the DC switch (M4)a | |

NOTE

Note a: (Optional) Remove the plastic cap and install a locking screw for the DC switch to prevent misoperations.

Battery Expansion Module

The standard capacity of a battery expansion module is 5 kWh.

Figure 2-8 Battery expansion module

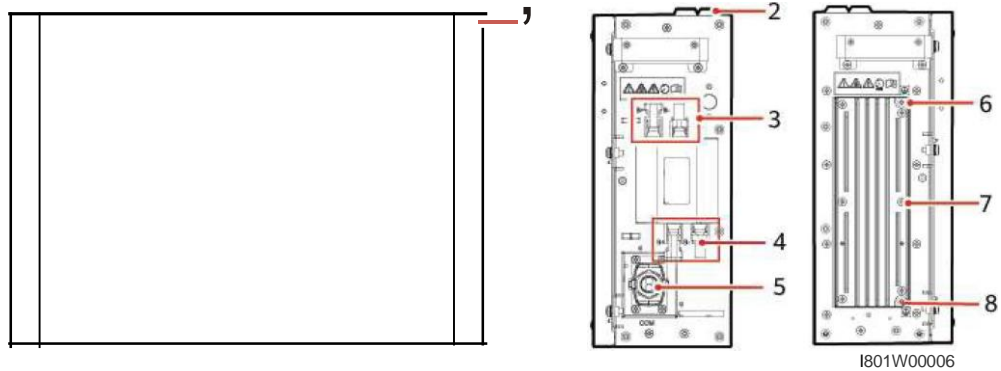

- | | | |
|---|------------------------|---|
| (1) Battery expansion module | (2) Boss for alignment | (3) Battery cascading terminals (B+/B-) |
| (4) Battery cascading terminals (B+/B-) | (5) COM port (COM) | (6) Ground point |
| (7) Heat sink | (8) Ground point | |

2.3 Label Description

Enclosure Labels

Table 2-4 Enclosure label description

Icon	Name	Meaning
	Burn warning	Do not touch the product, as the shell is hot when it is running.
	Delayed discharge	<ul style="list-style-type: none"> High voltage exists after the battery is powered off. It takes 5 minutes for the battery to discharge to the safe voltage.
	Operator	<ul style="list-style-type: none"> High voltage exists after the battery is powered on. Only qualified and trained electrical technicians are allowed to install and operate the battery. Ground the battery before powering it on.
	Refer to documentation	Reminds operators to refer to the documentation provided with the equipment.
	Grounding	Indicates the position for connecting the PE cable.

NOTE

The labels are for reference only.

2.4 Features

Multi-Scenario and Multi-Working Mode

- Supports multiple working modes such as grid-tied, grid-tied and off-grid, pure off-grid multi-scenario, self-consumption, TOU (time-of-use), and full fed to the grid modes.
- Allows users to query the total discharge capacity in the product life cycle in real time.

Intelligent and Simple Operation

Works with the inverter, supports plug-and-play, and integrates the mobile phone app and management system.

Easy Installation and Replacement

- Standard battery DC terminals are used for system connection.
- Modular design is adopted for batteries.
- The installation or replacement can be performed by two persons.

Flexible Scalability

The battery supports power expansion, battery capacity expansion, and hybrid use of old and new batteries.

Intelligent O&M

- The factory defaults meet the requirements of target markets and the battery can be started by pressing only one button and supports black startup.
- The LED indicator shows the status. You can also use the mobile phone app to perform local and remote operations.
- The cloud data management system is used to manage the battery anytime and anywhere.

Low Investment

- Only common installation tools are required.
- The battery features high efficiency and power density, which saves installation space.
- The battery features easy O&M.

2.5 Working Mode

The Power Saver converts HVDC generated by PV strings into low-voltage direct current (LVDC) through DC-to-DC conversion and stores the power in batteries. It can also convert LVDC into HVDC and then into AC power through the inverter.

Working Mode

The Power Saver battery can work in hibernation, standby, or operating

mode. **Table 2-5** Working mode

Working Mode	Description
Hibernation mode	The internal auxiliary power source and DC-DC converter of the battery do not work.
Standby mode	The auxiliary power source inside the battery works, and the DC-DC converter does not work.
Operating mode	The internal auxiliary power source of the battery works, and the DC-DC converter charges or discharges.

Figure 2-11 Switchover among working modes

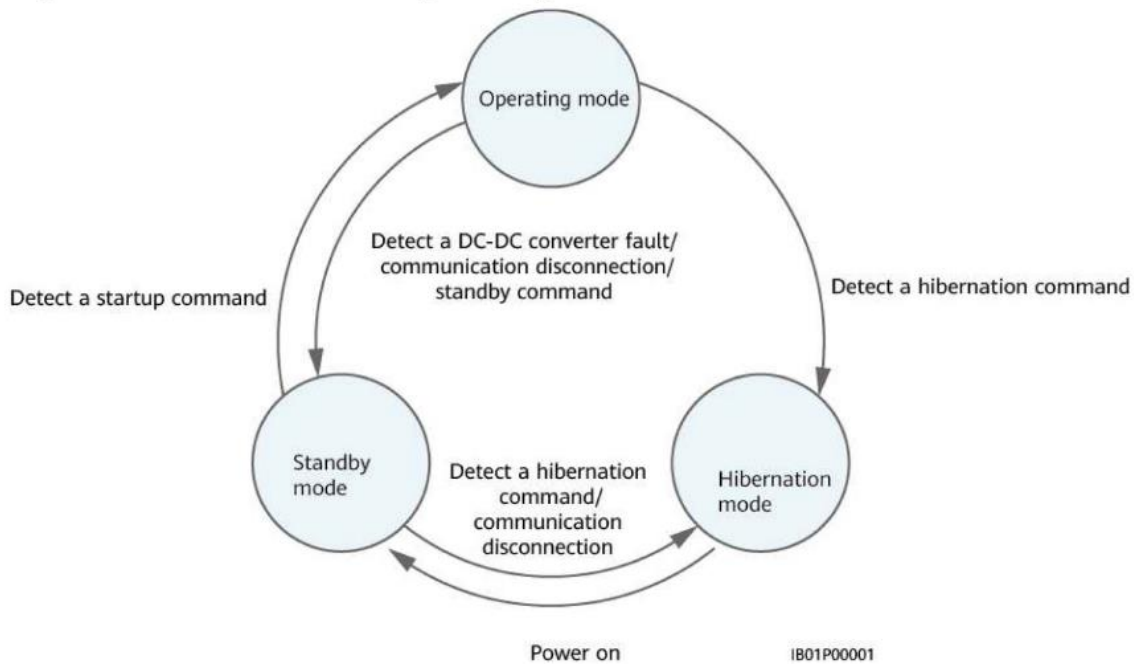

3 Transportation and Storage

3.1 Transportation Requirements

- If multiple persons need to move a heavy object together, determine the manpower and work division with consideration of height and other conditions to ensure that the weight is equally distributed.
- If two persons or more move a heavy object together, ensure that the object is lifted and landed simultaneously and moved at a uniform pace under the supervision of one person.
- Wear personal protective gears such as protective gloves and shoes when manually moving the equipment.
- To move an object by hand, approach to the object, squat down, and then lift the object gently and stably by the force of the legs instead of your back. Do not lift it suddenly or turn your body around.
- Do not quickly lift a heavy object above your waist. Place the object on a

workbench that is half-waist high or any other appropriate place, adjust the positions of your palms, and then lift it.

- Move a heavy object stably with balanced force at an even and low speed. Put down the object stably and slowly to prevent any collision or drop from scratching the surface of the equipment or damaging the components and cables.
- When moving a heavy object, be aware of the workbench, slope, staircase, and slippery places. When moving a heavy object through a door, ensure that the door is wide enough to move the object and avoid bumping or injury.

- When transferring a heavy object, move your feet instead of turning your waist around. When lifting and transferring a heavy object, ensure that your feet point to the target direction of movement.
- When transporting the equipment using a pallet truck or forklift, ensure that the tynes are properly positioned so that the equipment does not topple. Before moving the equipment, secure it to the pallet truck or forklift using ropes. When moving the equipment, assign dedicated personnel to take care of it.
- Choose sea or roads in good conditions for transportation as transportation by railway or air is not supported. Avoid tilt or jolt during transportation.

DANGER

Load or unload batteries with caution. Otherwise, the batteries may be short-circuited or damaged (such as leakage and crack), catch fire, or explode.

& WARNING

Do not move a battery by holding its terminals, bolts, or cables. Otherwise, the battery may be damaged.

Keep batteries in the correct direction during transportation. They must not be placed upside down or tilted, and must be protected against falling down, mechanical impact, rains, snows, and falling into water during transportation.

& WARNING

Before unpacking, storage, and transportation, ensure that the packing cases are intact and the batteries are correctly placed according to the labels on the packing cases. Do not place a battery upside down or vertically, lay it on one side, or tilt it. Stack the batteries according to the stacking requirements on the packing cases. Ensure that the batteries do not fall or get damaged. Otherwise, they will need to be scrapped.

- Batteries have obtained the certifications of the UN38.3 (UN38.3: section 38.3 of the sixth Revised Edition of the Recommendations on the Transport of Dangerous Goods, Manual of Tests and Criteria) and SN/T 0370.2-2009 (Part 2: Performance Test of the Rules for the Inspection of Packaging for Exporting Dangerous Goods). The batteries belong to class 9 dangerous goods.
- The transportation service provider must be qualified to transport dangerous goods. Open truck transportation is not allowed.
- Batteries can be delivered to the site directly if the road or sea transportation requirements are met.
- Comply with the international regulations on the transport of dangerous goods and meet the requirements of the transportation regulatory authorities in the countries of departure, route, and destination.
- Choose sea or roads in good conditions for transportation. Do not transport batteries by railway or air. Avoid tilt or jolt during transportation.

- Maritime transport must comply with the *International Maritime Dangerous Goods Code* (IMDG Code).
- Road transport must comply with the *Agreement Concerning the International Carriage of Dangerous Goods by Road* (ADR) or JT/T 617.
- Before transportation, check that the battery package is intact and that there is no abnormal odor, leakage, smoke, or sign of burning. Otherwise, the batteries cannot be transported.
- The packing case must be secured for transportation. Handle the case with care during loading and unloading, and take moisture-proof measures during transportation.
- Exercise caution when moving batteries to prevent bumping and ensure personal safety.
- Unless otherwise specified, dangerous goods cannot be mixed with goods containing food, medicine, animal feed, or their additives in the same vehicle or container.
- Unless otherwise specified, when dangerous goods packages are loaded in the same vehicle or container as ordinary goods, they should be separated in either of the following ways:
 - Use a spacer that is as high as the packages.
 - Keep a distance of at least 0.8 m around.
- Before transporting a faulty battery (with scorch, leakage, bulge, or water intrusion), insulate its positive and negative terminals, pack it, and place it in an insulated explosion-proof box as soon as possible. Record information such as the site name, address, time, and fault symptom on the box.
- When transporting faulty batteries, avoid approaching flammable material storage areas, residential areas, or other densely populated places, such as mass transit facilities or elevators.

3.2 Storage Requirements

& WARNING

- Ensure that batteries are stored in a dry, clean, and ventilated indoor environment that is free from sources of strong infrared or other radiations, organic solvents, corrosive gases, and conductive metal dust. Do not expose batteries to direct sunlight or rain and keep them far away from sources of heat and ignition.
- If a battery is faulty (with scorch, leakage, bulge, or water intrusion), move it to a dangerous goods warehouse for separate storage. The distance between the battery and any combustible materials must be at least 3 m. The battery must be scrapped as soon as possible.
- Place batteries correctly according to the signs on the packing case during storage. Do not place batteries upside down, lay them on one side, or tilt them. Stack batteries in accordance with the stacking requirements on the packing cases.
- Store batteries in a separate place. Do not store batteries together with other devices. Do not stack batteries too high. If a large number of batteries are stored onsite, the site should be equipped with qualified fire fighting facilities, such as fire sand and fire extinguishers.

& CAUTION

Batteries should be used soon after being deployed onsite. Batteries that have been stored for an extended period should be charged periodically. Otherwise, they may be damaged.

-
- The storage environment must comply with local regulations and standards.
 - The storage environment must be clean and dry. The product must be protected against rain and water.
 - The air must not contain corrosive or flammable gases.
 - The storage environment requirements are as follows:
 - Ambient temperature: -10-55°C; recommended storage temperature: 20-30°C
 - Relative humidity: 5% to 80%
 - If equipment except battery packs has been stored for more than two years, it must be checked and tested by professionals before use.
 - Proof that the product is stored according to the requirements must be available, such as temperature and humidity log data, storage environment photos, and inspection reports.
 - Ensure that batteries are delivered based on the "first in, first out" rule.

- Ensure that the storage duration starts from the latest charge time marked on the battery packing case and that the latest charge time is updated after every charge.

4 Application Scenarios and Settings

The Power Saver battery is mainly used in grid-tied systems of residential rooftop PV plants and small-scale PV plants in industrial and commercial scenarios. The system can be classified into the following three types based on application scenarios:

- Grid-tied energy storage system (ESS)
- Grid-tied and off-grid ESS
- Off-grid ESS

Multiple working modes can be set, such as maximum self-consumption, TOU (time-of-use), and fully fed to the grid.

NOTE

- The Power Saver batteries can be used only with DTSU666-HW, YDS60-80, YDS70-C16, YDS60-C24, DDSU666-H and DTSU666-H meters.
- If no PV module is installed in the system, only the TOU mode is supported.

4.1 Grid-tied ESS

4.1.1 Grid-tied ESS Networking

Networking 1: Single Inverter

The grid-tied ESS consists of PV strings, Power Saver batteries, inverter, AC switch, loads, power distribution unit (PDU), power meter, and grid.

Svea Solar Power Shifter inverters are supported.

The PV string converts solar energy into electric energy, which is then converted by the inverter to power loads or be fed to the grid.

Figure 4-1 Grid-tied ESS networking diagram (dashed boxes indicate optional components)

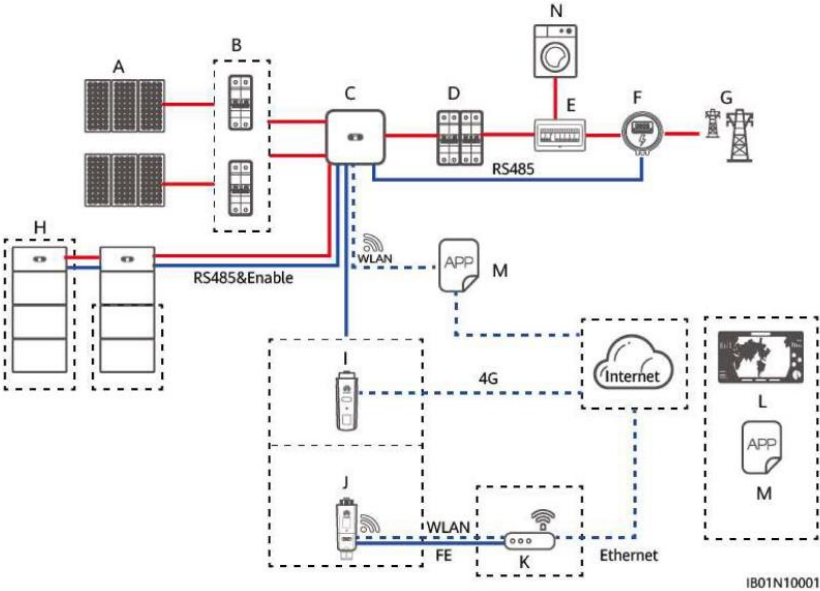

Networking 2: Multiple Inverters Cascaded

You can add inverters and batteries to increase capacity. A maximum of three inverters can be cascaded. Each battery connects to the inverter through an independent RS485 port and is managed by the inverter connected to it.

Smartlogger Networking

- Smartlogger V300R001C00SPC100 and later versions are supported in this scenario. For details about commissioning, see [6.3 "Battery Commissioning"](#).
- The grid-tied ESS supports cascading of Svea Solar Power Shifter inverters

Table 4-2 Mapping relationship

Smart Dongle Networking

- The grid-tied ESS supports inverter cascading. A maximum of three inverters can be cascaded. The batteries can be connected to one of the inverters for management. The batteries, power meter, and Smart Dongle need to be connected to the same inverter.
- When the battery working mode is set to **Maximum self-consumption** or **TOU (time-of-use)**, the Smart Dongle must be connected. If the working mode is set to **Fully fed to grid**, the Smart Dongle is optional.

Figure 4-4 Smart Dongle networking (dashed boxes indicate optional components)

Figure 4-4 Smart Dongle networking (dashed boxes indicate optional components)

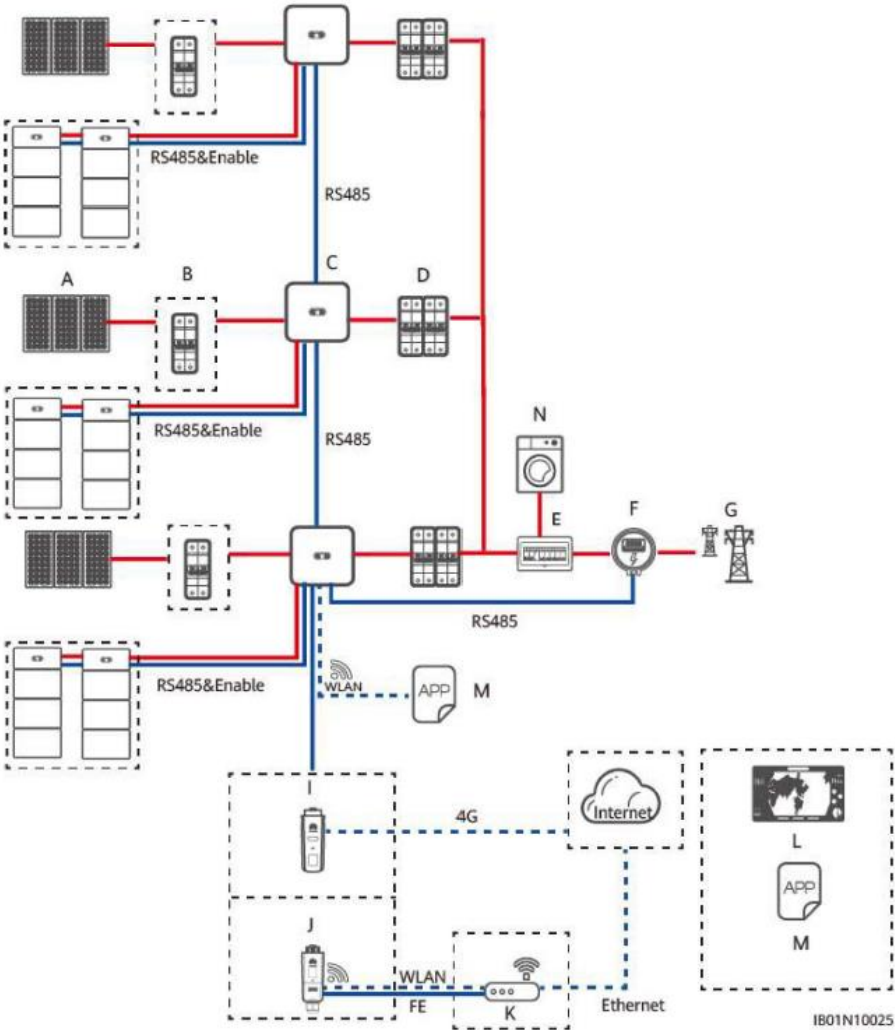

IB01N10025

NOTE

- When the grid charging function is enabled, the surplus power generated by the inverter without batteries can be used to charge the inverter connected to the batteries.
- The parameters of each battery need to be set separately. When the grid charging function is enabled, the surplus power generated by one inverter can be used to charge the other inverter.

(A) PV string	(B) DC switch	(C) Inverter
(D) AC switch	(E) AC/DC	(F) Smart Power Sensor
(G) Power grid	(H) Power Saver	(I) 4G Smart Dongle
(J) WLAN-FE Smart Dongle	(K) Router	(L) FusionSolar management system
(M) FusionSolar app	(N) Load	(Q) SmartLogger

NOTE

-- indicates a power cable, --- indicates a signal cable, * ----- indicates wireless communication.

4.1.2 Setting the Grid-tied ESS Mode

The grid-tied ESS has three main working modes: Maximum self-consumption, TOU (time-of-use), and excess fed to the grid.

Maximum Self-Consumption

- This mode applies to areas where the electricity price is high, or areas where the FIT subsidy is low or unavailable.
- Excess PV energy is stored in batteries. When PV power is insufficient or no PV power is generated at night, batteries discharge to supply power to the loads, improving the self-consumption rate of the PV system and the self-sufficiency rate of residential energy, and reducing electricity costs.
- In this mode, **Maximum self-consumption** is selected. By default, the charge cutoff capacity is 100% and the discharge cutoff capacity is 5% for Power Saver batteries. For details about how to change the charge or discharge cutoff capacity, see [7.3 Battery Commissioning](#).

Figure 4-5 Battery control parameter setting

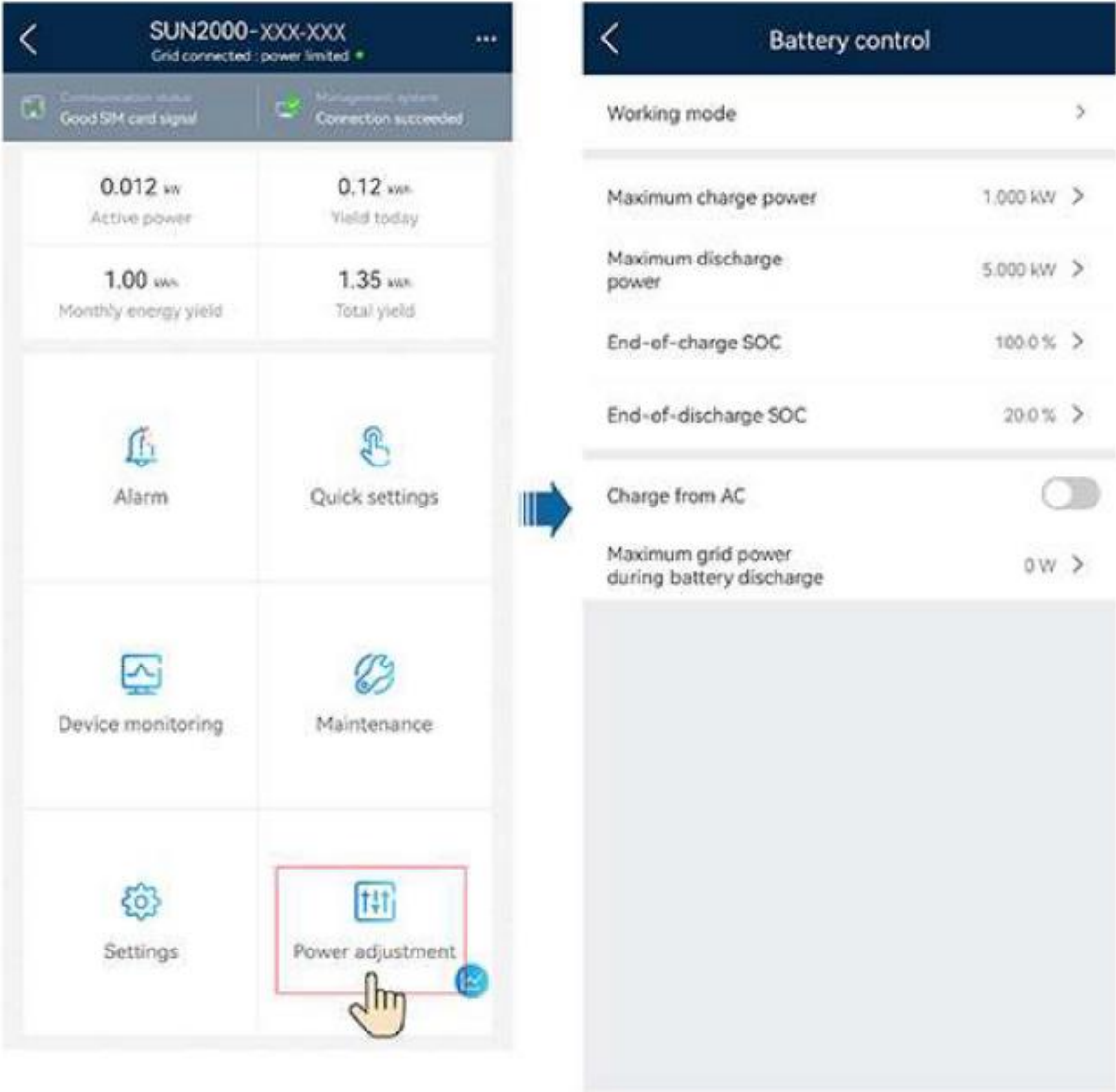

4.1.3

Parameter	Description	Value Range
Working mode	Set this parameter to the maximum self-consumption mode.	<ul style="list-style-type: none"> Maximum self-consumption TOU (time-of-use) Fully fed to grid
Maximum charge power (kW)	Retain this parameter to the maximum charge power. Additional configuration is not required. If only one battery expansion module is configured, the maximum charge power is 2.5 kW.	[0, Maximum charge power]
Maximum discharge power (kW)	Retain this parameter to the maximum discharge power. Additional configuration is not required. If only one battery expansion module is configured, the maximum charge power is 2.5 kW.	[0, Maximum discharge power]
End-of-charge SOC (%)	Set the charge cutoff capacity.	190%-100%
End-of-discharge SOC (%)	Set the discharge cutoff capacity.	0%-20%

NOTE

If no PV modules are installed or the system has not detected sunlight for at least 24 hours, the minimum end of discharge SOC is 15%.

Example of Self-Consumption

Examples of self-consumption:

(1) When the sunlight is sufficient, the PV module outputs 8 kW power, the loads consume 4 kW power, and the batteries charge 4 kW power.

(2) When the sunlight becomes weak, the PV module outputs 3 kW power, the loads consume 4 kW power, and the batteries discharge to supply 1 kW power to the loads.

Figure 4-6 Example of Self-Consumption

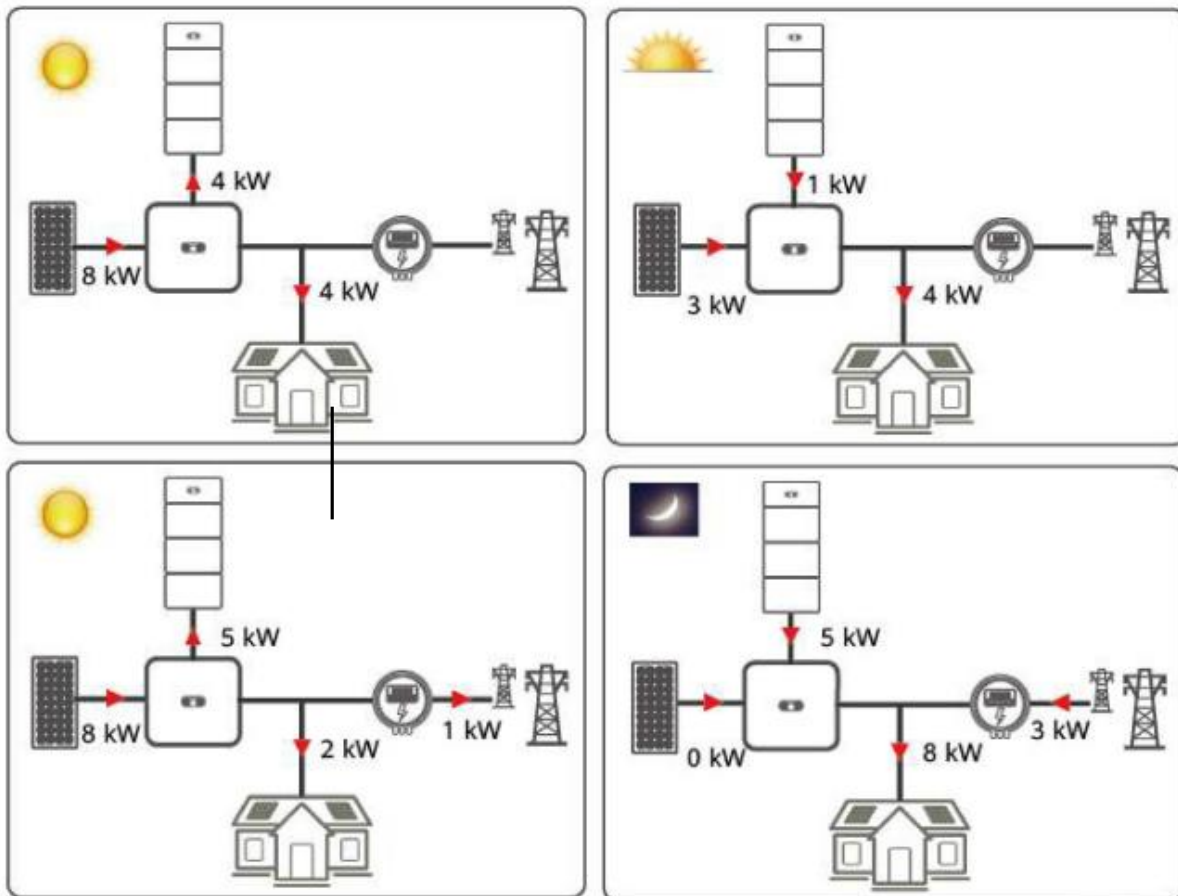

IB01N0001

TOU (time-of-use)

- This mode applies to scenarios where the price difference between peak and off-peak hours is large.
- In this mode, **TOU (time-of-use)** is selected. You can manually set the charge and discharge time segments. For example, you can allow the grid to charge batteries in low electricity price periods at night and discharge batteries during high electricity price periods, saving electricity fee. The charge from grid function must be enabled.
- A maximum of 14 time segments can be set. For details about how to set charge and discharge parameters, see [7.3 Battery Commissioning](#).
- In some countries, the grid is not allowed to charge batteries. Therefore, this mode cannot be used.
- This mode requires at least one charging period and one discharging period, the grid charges batteries during the charge time and supplies power to loads during the discharge time. In other time segments that are not set, the batteries do not discharge, and the PV modules and grid supply power to loads. (In grid-tied and off-grid mode, if the grid is powered off, the batteries can discharge at any time.)

Figure 4-7 TOU (time-of-use) working mode



Table 4-5 TOU (time-of-use) mode setting

Parameter	Description	Value Range
Priority of excess PV energy	<ul style="list-style-type: none"> • Charge: When the generated PV energy is greater than the loads, excess PV energy is used to charge the batteries. After the maximum charge power is reached or the batteries are fully charged, the excess PV energy is fed to the grid. • Fed to grid: When the generated PV energy is greater than the loads, the excess PV energy is preferentially fed to the grid . When the inverter output power reaches the maximum value, the excess energy is used to charge batteries. This setting is applicable to the scenario where the FIT is higher than the electricity price. Batteries are used only for backup power. 	<ul style="list-style-type: none"> • Charge • Fed to grid

Allowed charge power of grid (kW)	Indicates the maximum charge power allowed by the grid. The value is determined by the local grid company. If there is no requirement, the value is the maximum charge power of the ESS by default.	<ul style="list-style-type: none"> • [0, Maximum charge power allowed by the grid]
-----------------------------------	---	---

Table 4-6 TOU (time-of-use) parameter setting

Parameter	Description	Value Range
Charge from grid	If Charge from grid function is disabled by default, comply with the grid charge requirements stipulated in local laws and regulations when this function is enabled.	<ul style="list-style-type: none"> • Disable • Enable
Grid charge cutoff SOC	Set the grid charge cutoff state of charge (SOC).	[20%, 100%]

Example of the TOU {time-of-use) electricity price

Examples of the TOU (time-of-use) electricity price:

Set power consumption peak hours (14:00 to 24:00) as the discharge time. During this time, the batteries discharge. During other periods, such as 03:00-14:00 , surplus PV energy can be used to charge the batteries, and the batteries do not discharge. When the load power supply is insufficient, the grid supplies power to the loads. For example, when the sunlight is insufficient, the PV module outputs 3

kW power, the loads consume 4 kW power, and the grid supplies 1 kW power to the loads.

Figure 4-8 Battery control parameter setting

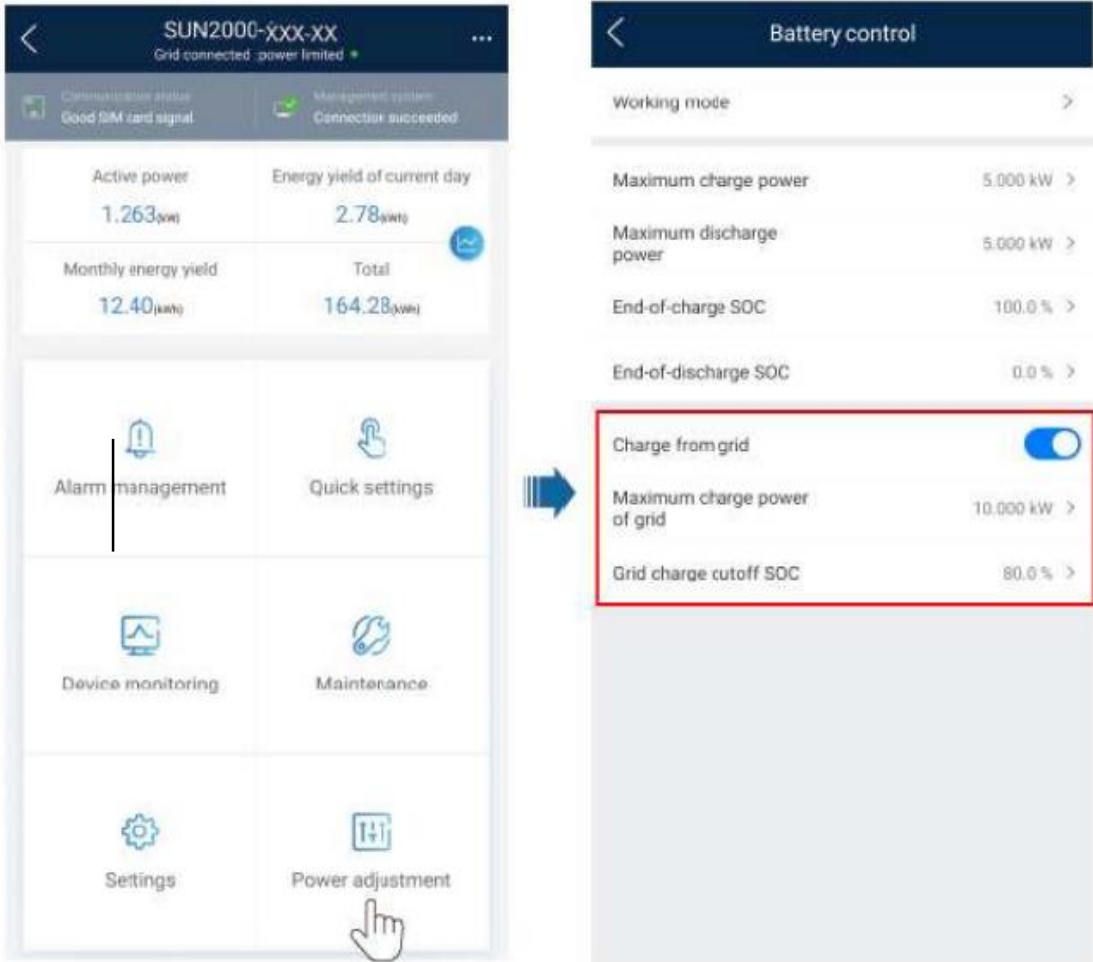
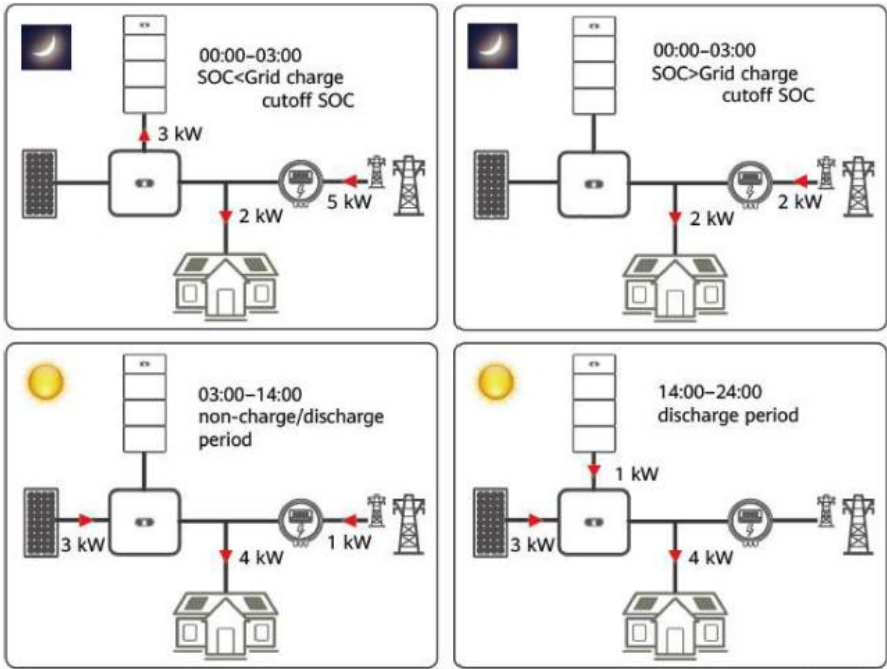

Figure 4-9 TOU (time-of-use) (charge period 00:00-03:00/discharge period 14:00-24:00)

Figure 4-9 TOU (time-of-use) (charge period 00:00-03:00/discharge period 14:00-24:00)



Fully Fed to Grid

- This mode applies to the grid-tied scenario where PV energy is fully fed to the grid.
- This mode maximizes the PV energy for grid connection. When the generated PV energy in the daytime is greater than the maximum output capability of the inverter, the batteries are charged to store energy. When the PV energy is less than the maximum output capability of the inverter, batteries discharge to maximize the output energy of the inverter to the grid.
- In this mode, **Fully fed to grid** is selected. For details, see [7.3 Battery Commissioning](#).

Example of fully fed to grid:

For example, when the PV modules generate 8 kW power, the Power Shifter -6kW inverter connects to the grid with the maximum output power of 6.5 kW, and the batteries charge 2.5 kW power. When the sunlight becomes weak, the PV modules generate 3 kW power, the batteries charge 3.5 kW power, and the inverter connects to the grid with the maximum output power of 6.5 kW.

Figure 4-10 fully fed to grid

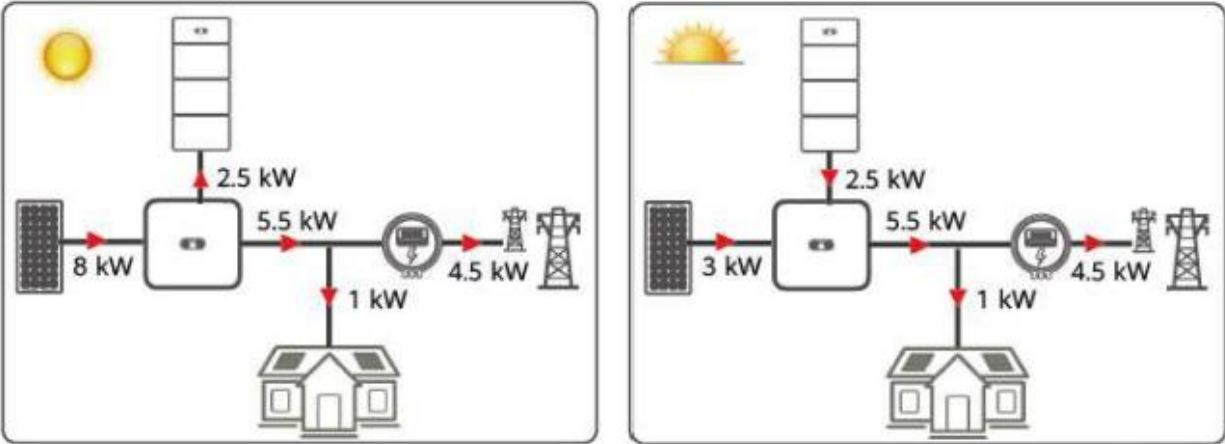

5 System Installation

Lt, DANGER

Note the polarities when installing batteries. Do not connect the positive and negative poles of a battery or battery string together. Otherwise, the battery may be short-circuited.

ffi WARNING

- Tighten the screws on copper bars or cables to the torque specified in this document. Periodically confirm whether the screws are tightened, check for rust, corrosion, or other foreign objects, and clean them up if any. Loose screw connections will result in excessive voltage drops and batteries may catch fire when the current is high.
 - When installing batteries, do not place installation tools, metal parts, or sundries on the batteries. After the installation is complete, clean up the objects on the batteries and the surrounding area.
-

ffi WARNING

After unpacking batteries, place them in the required direction. Do not place a battery upside down or vertically, lay it on one side, tilt it, or stack it. Ensure that the batteries do not fall or get damaged. Otherwise, they will need to be scrapped.

& CAUTION

- Slowly push or move battery packs to prevent damage and collision.
 - To prevent battery packs from falling off, start the pallet truck or forklift after confirming that battery packs are securely bound.
 - When moving batteries, do not remove protective components such as protective covers or waterproof caps from battery terminals.
 - Exercise caution when moving batteries to prevent bumping and ensure personal safety.
 - Install and secure batteries horizontally from the bottom up and from left to right to prevent falling over due to imbalance.
 - When connecting batteries, ensure that the spring washer on the screw is leveled, that the protruding part of the terminal on the cable faces outwards, and that the cable is intact.
-

& CAUTION

- Install and secure batteries horizontally from the bottom up and from left to right to prevent falling over due to imbalance.
 - Ensure that the power circuit breaker is OFF before installing batteries.
 - Keep the battery loop disconnected during installation and maintenance.
-

NOTICE

- Do not use a damaged battery (such as damage caused when a battery is dropped, bumped, bulged, or dented on the enclosure), because the damage may cause electrolyte leakage or flammable gas release. In the case of electrolyte leakage or structural deformation, contact the installer or professional O&M personnel immediately to remove or replace the battery. Do not store the damaged battery near other devices or flammable materials and keep it away from non-professionals.
 - Before installing battery packs, check whether they are abnormal. A battery pack is deemed abnormal when any of the following symptoms occurs:
 - The enclosure of the battery pack is obviously deformed or damaged.
 - The voltage between the positive and negative electrodes of the battery pack is far below the specified range.
-

5.1 Checking Before the Installation

Checking the Outer Packing

Before unpacking the battery, check the outer packing for damage, such as holes and cracks, and check the battery model. If any damage is found or the battery model is not what you requested, do not unpack the product and contact your dealer as soon as possible.









Checking Deliverables

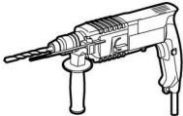
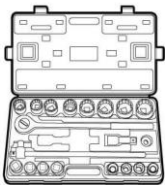

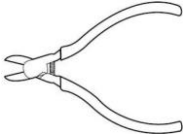
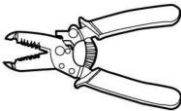
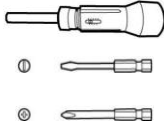
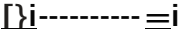





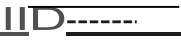

After unpacking the battery, check that the deliverables are intact and complete, and free from any obvious damage. If any item is missing or damaged, contact your dealer.

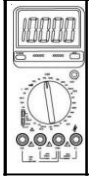
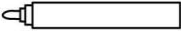
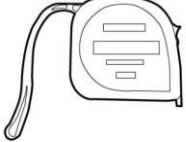
NOTE

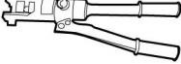
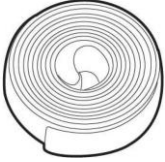
For details about the number of deliverables delivered with the battery, see the *Packing List* in the packing case.

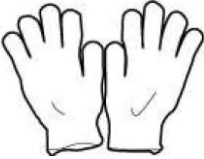
5.2 Preparing Tools and Instruments

Type	Tools and Instruments		
Installation	 Hammer drill (with a drill bit of 8 mm)	 Torque socket wrench	 Torque wrench
	 Diagonal pliers	 Wire strippers	 Torque screwdriver
	 Rubber mallet	 Utility knife	 Cable cutter
	 Crimping tool (model: PV-CZM-22100/19100)	 Cord end terminal crimper	 Disassembly and Assembly Tool (model: PV-MS-HZ open-end wrench)

Type	Tools and Instruments		
	 Cable tie	 Vacuum cleaner	 Multimeter (DC voltage measurement range 600 V DC)
	 Marker	 Steel measuring tape	 Level
	 Hydraulic pliers	 Heat-shrink tubing	 Heat gun
Personal protective equipment (PPE)	 Insulated gloves	 Protective gloves	 Dust mask
	 Safety boots	 Safety goggles	

5.3 Determining the Installation Position

Installation Angle Requirement

The battery can be floor-mounted and wall-mounted. The installation angle requirement is as follows:

- Do not install the battery at forward tilted, back tilted, side tilted, horizontal, or upside down positions.

Installation Position Requirements

Install the battery on a solid brick-concrete structure or concrete wall or floor. If other types of walls and floors are used, they must be made of fire-retardant materials and meet the load-bearing requirements of the equipment.

Installation Space Requirements

- During installation, ensure that there is no other devices or flammable or explosive materials around the batteries. Reserve adequate space for heat dissipation and safety isolation.
- When the battery is mounted on a wall, do not place any objects under the battery.

Figure 5-1 Installation space

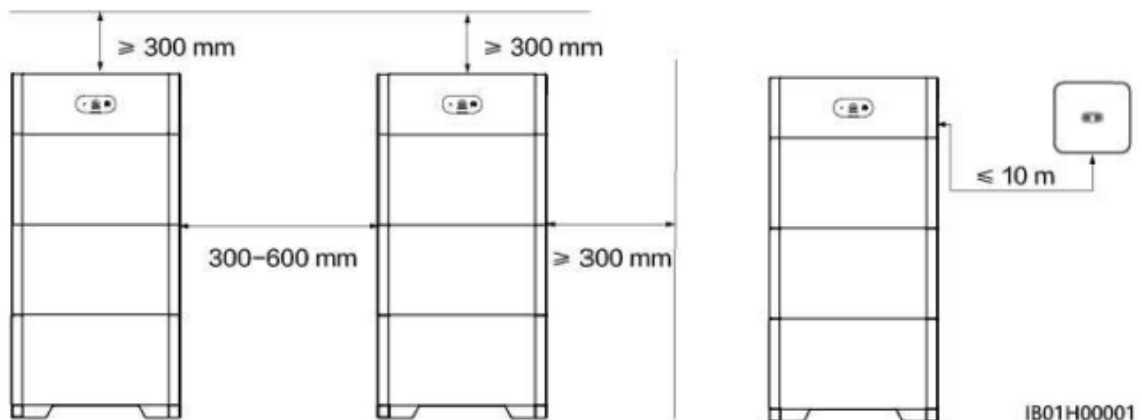

5.4 Equipment Installation

5.4.1 Floor-Mounted Installation

Installation Precautions

Figure 5-2 shows the dimensions of mounting holes for a battery.

Figure 5-2 Floor-mounted installation dimensions

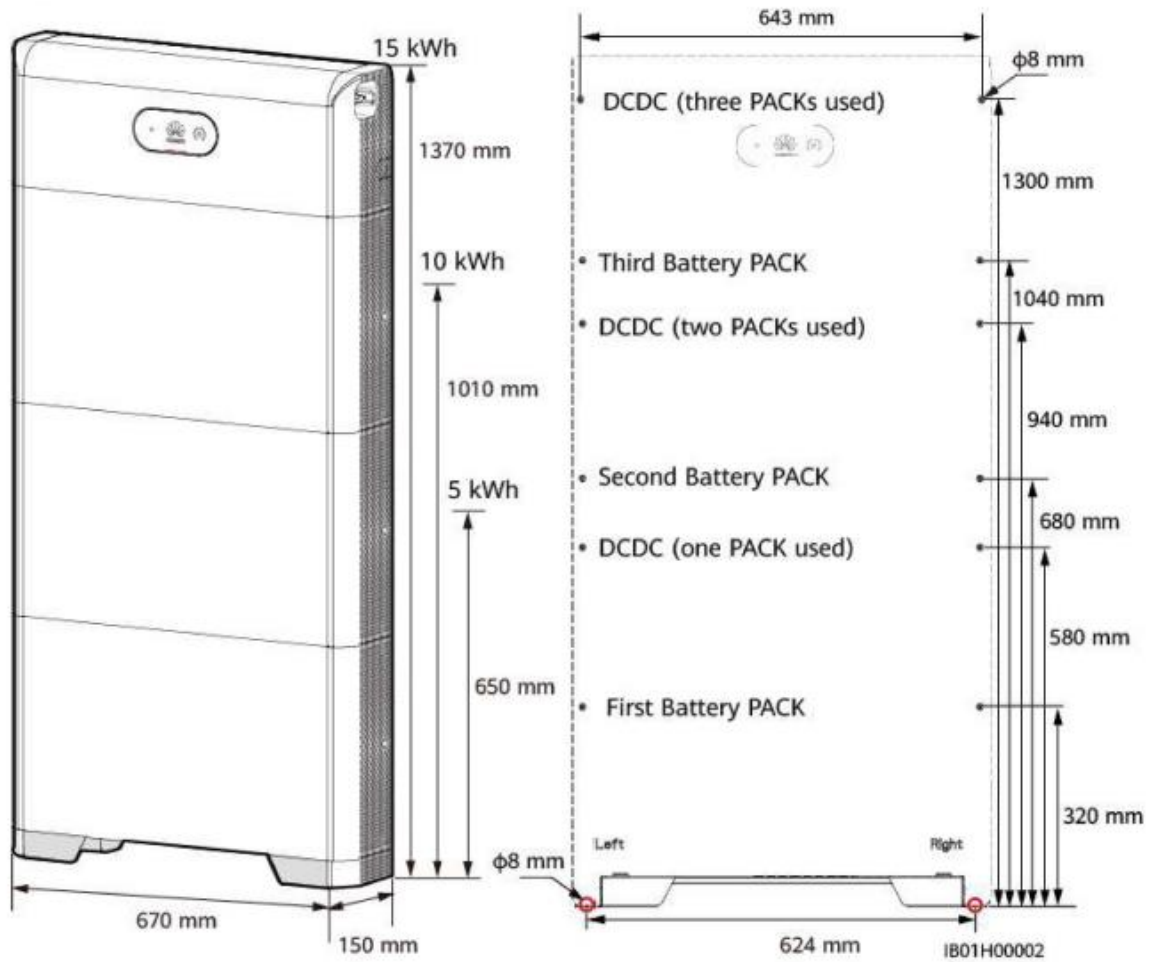

Procedure

- Step 1** Align the floor support with the wall surface and keep the support 10 mm to 15 mm away from the wall surface. Level the hole positions using a level, and mark the hole positions for installing the floor support using a marker. Align the marking-off template with the surface of the floor mounting kit, determine the drilling hole positions on the wall for securing the power control module, and mark the positions using a marker.
- Step 2** Install the floor support.

A. DANGER

When drilling holes, avoid the water pipes and power cables buried in the wall.

NOTE

M6x60 expansion bolts delivered with the battery are used to install the floor support and power control module. If the length and quantity of the bolts do not meet installation requirements, prepare M6 stainless steel expansion bolts by yourself. The expansion bolts delivered with the battery are mainly used for solid concrete walls and concrete floors. If other types of walls and floors are used, ensure that the walls and floors meet the load-bearing requirements (one battery expansion module weighs 50 kg) and select the bolts by yourself.

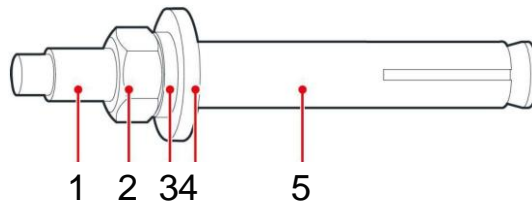
Figure 5-3 M6 expansion bolt structure diagram

IS05W00018

- (1) Bolt (2) Nut (3) Spring washer
(4) Flat washer (R) Expansion sleeve

NOTICE

- To prevent dust inhalation or contact with eyes, wear safety goggles and an anti-dust mask when drilling holes.
- Wipe away any dust in or around the holes and measure the hole distances. If the holes are inaccurately positioned, drill holes again.
- Level the head of the expansion sleeve with the concrete wall or floor after removing the nut, spring washer, and flat washer. Otherwise, the mounting kit will not be securely installed on the wall or ground.
- Loosen the nut, spring washer, and flat washer of the expansion bolt at the bottom.

Figure 5-4 Installing expansion bolts

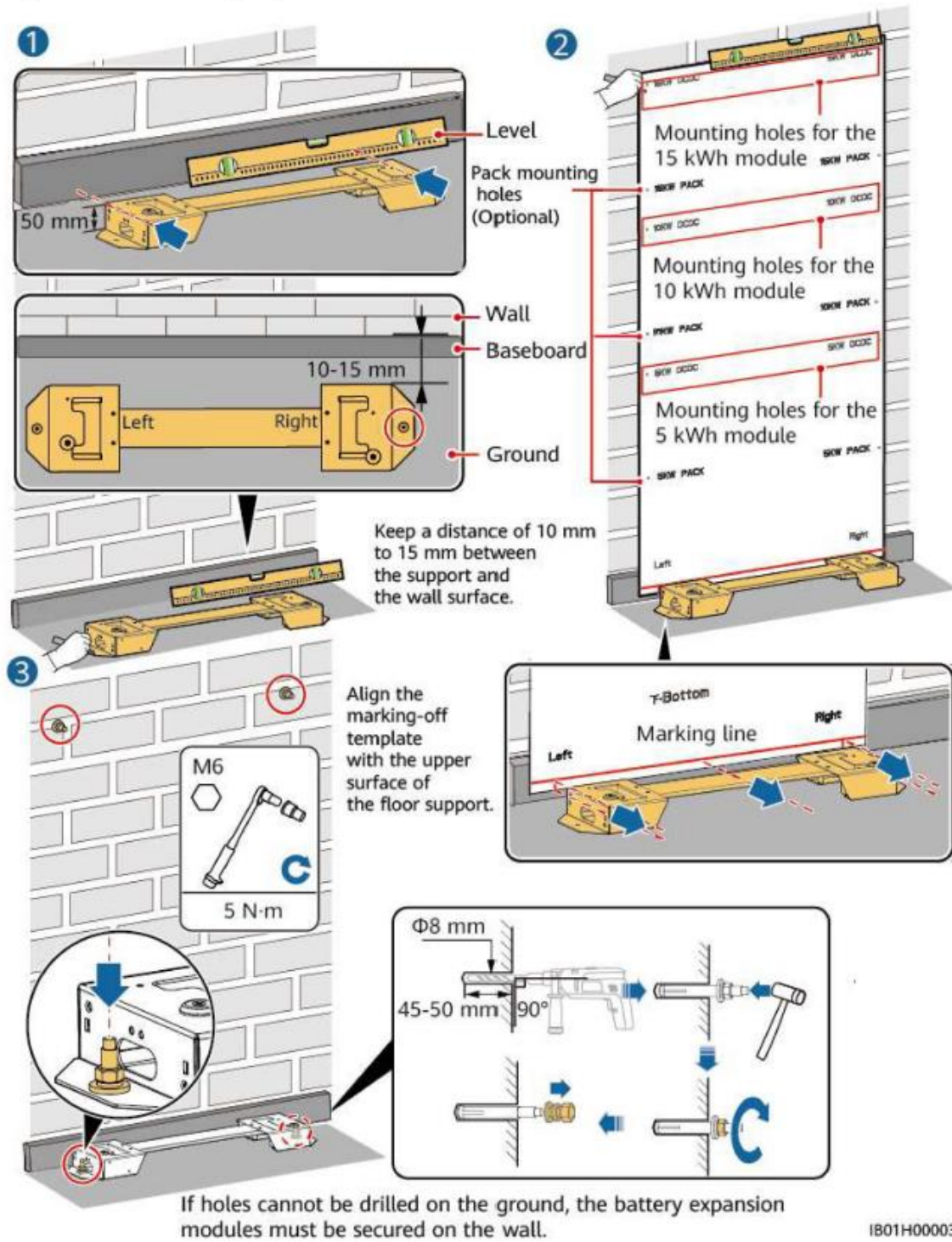

- Step 3** Place the first battery expansion module on the floor support, install the connecting pieces on both sides, and tighten the four screws. Install the remaining battery expansion modules and power control module from bottom to top.



After installing a module, install and tighten the connecting pieces and screws on the left and right sides of the module, and then install the next module.

Figure 5-5 Installing the battery expansion modules and power control module

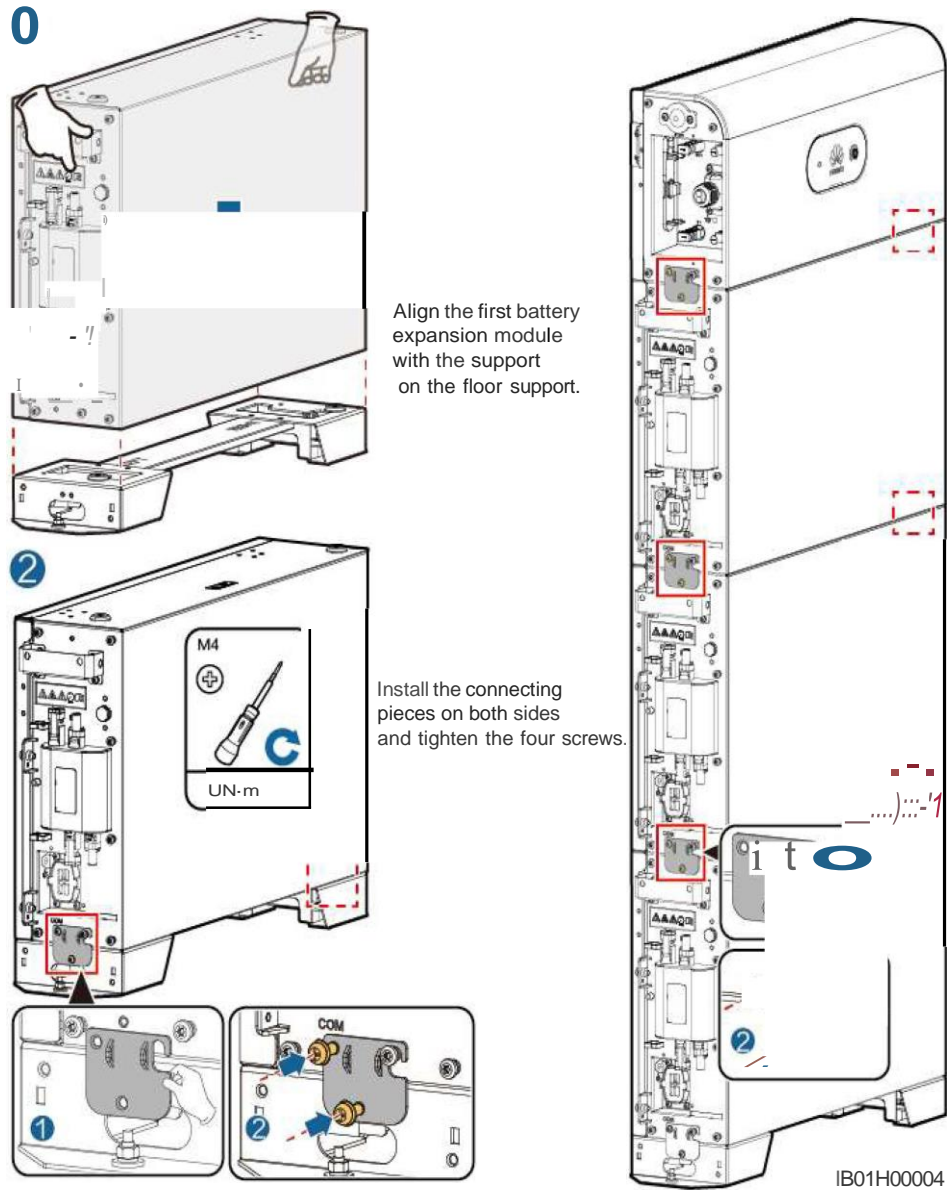

Install the remaining battery expansion modules and power control module from bottom to top.

Step 4 Secure the power control module to the wall.

⚠ WARNING

The power control module (DCDC) must be fixed on the wall. If the device is installed in an area prone to earthquakes or vibration, you can mark the battery module mounting holes and drill holes to install expansion bolts in step 2.

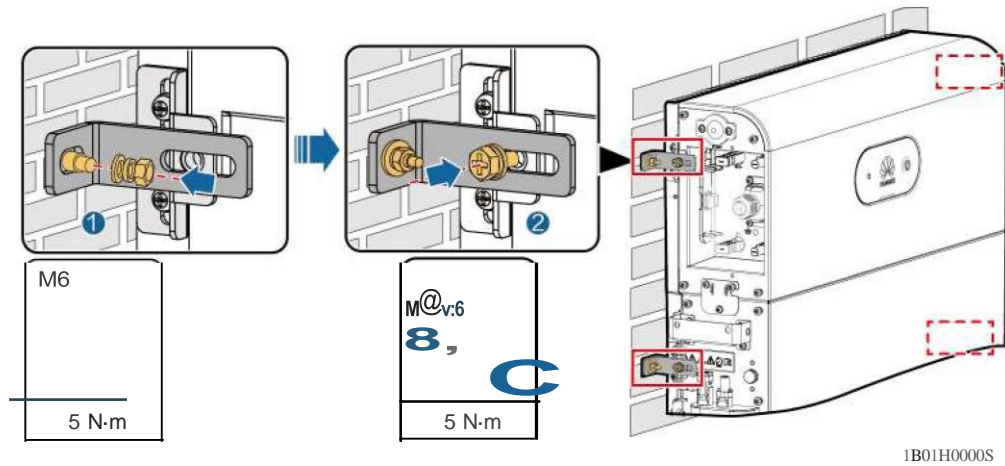
Figure 5-6 Fixing the power control module

----End

5.4.2 Wall-Mounted Installation

Installation Precautions

Figure 5-7 shows the dimensions of mounting holes for the battery on the wall.

Figure 5-7 Wall-mounted installation dimensions

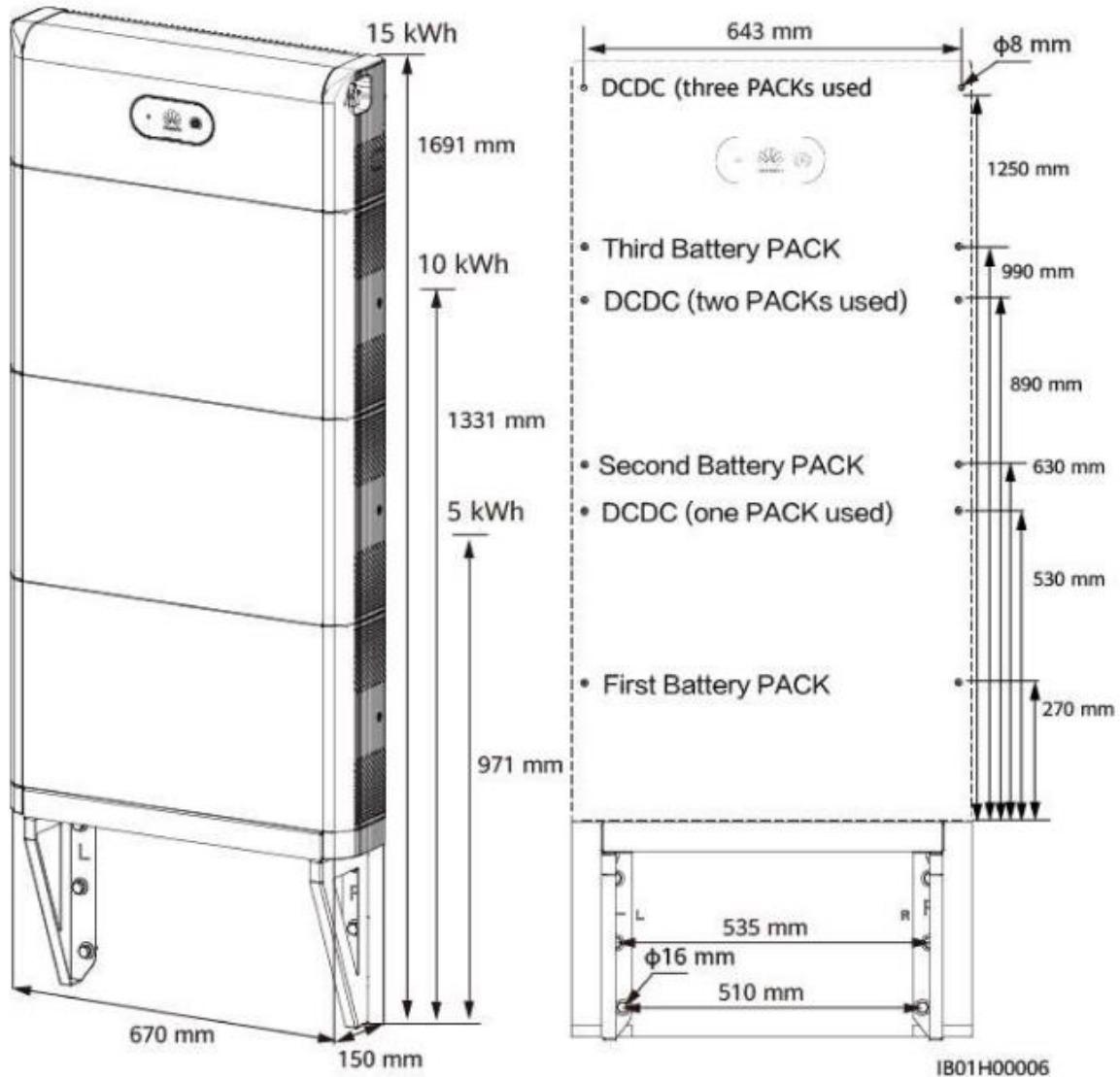

Procedure

- Step 1** Determine the positions for drilling holes using the marking-off template. Level the positions of mounting holes using a level, and mark the positions with a marker.
- Step 2** Install the mounting kit.

A. DANGER

When drilling holes, avoid the water pipes and power cables buried in the wall.

[O NOTE

- The expansion bolts delivered with the battery are mainly used for solid concrete walls and concrete floors. If other types of walls and floors are used, ensure that the walls and floors meet the load-bearing requirements (one battery expansion module weighs 50 kg) and select the bolts by yourself.
- M12x60 expansion bolts delivered with the battery are used to fix the wall mounting support. If the length and quantity of the bolts do not meet installation requirements, prepare M12 stainless steel expansion bolts by yourself.
- M6x60 expansion bolts delivered with the battery are used to fix the power control module and battery expansion module. If the length and quantity of the bolts do not meet installation requirements, prepare M6 stainless steel expansion bolts by yourself.

Figure 5-8 Wall-mounted installation

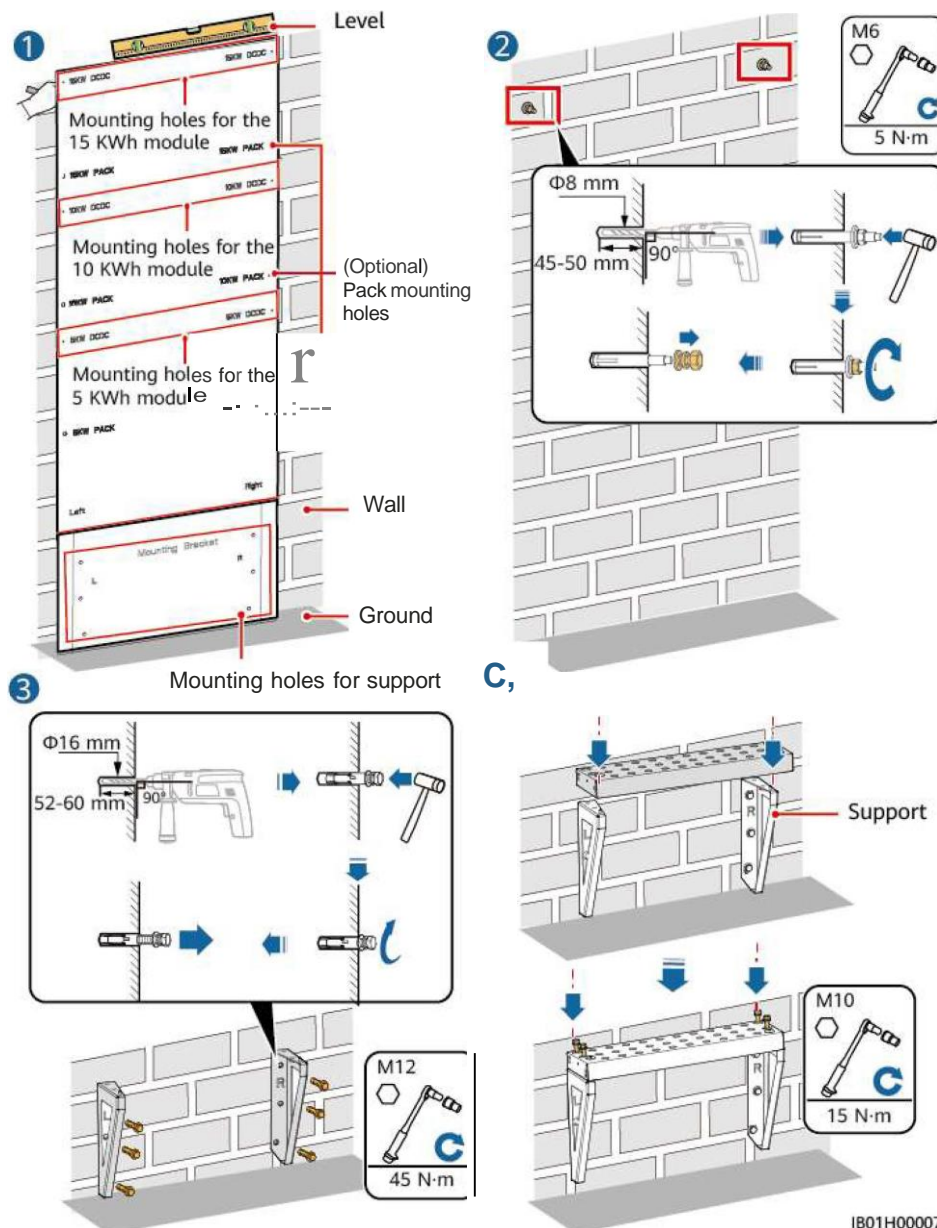

IB01H00007

Step 3 Place the first battery expansion module on the wall-mounted support, install the left and right connective pieces, and install the second battery expansion module, third battery expansion module, and power control module from bottom to top.

⚠ WARNING

After installing a module, install and tighten the connecting pieces and screws on the left and right sides of the module, and then install the next module.

Step 4 Secure the power control module and battery expansion modules to the wall.

⚠ WARNING

The power control module and battery expansion modules must be fixed on the wall to prevent them from falling down.

Figure 5-9 Fixing power control module

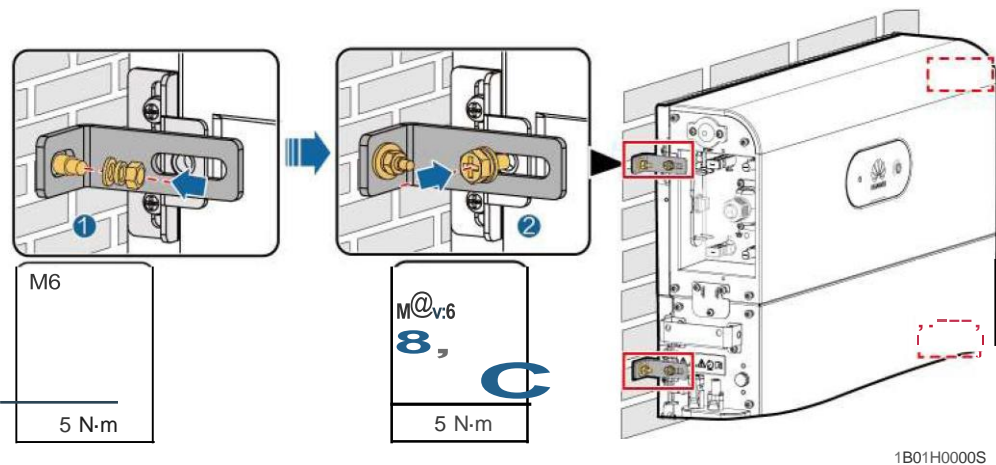

----End

6 Electrical Connection

Precautions

DANGER

Before connecting cables, ensure that the DC switch on the battery and all the switches connected to the battery are set to OFF. Otherwise, the high voltage of the battery may result in electric shocks.

DANGER

Note the polarities when installing batteries. Do not connect the positive and negative poles of a battery or battery string together. Otherwise, the battery may be short-circuited.

DANGER

- Do not smoke or have an open flame around batteries.
 - Wear personal protective equipment and use dedicated insulated tools to avoid electric shocks or short circuits.
-

ffi WARNING

- The equipment damage caused by incorrect cable connections is not covered under any warranty.
 - Only certified electricians are allowed to connect cables.
 - Operation personnel must wear proper PPE when connecting cables.
-

WARNING

- Tighten the screws on copper bars or cables to the torque specified in this document. Periodically confirm whether the screws are tightened, check for rust, corrosion, or other foreign objects, and clean them up if any. Loose screw connections will result in excessive voltage drops and batteries may catch fire when the current is high.
- When installing batteries, do not place installation tools, metal parts, or sundries on the batteries. After the installation is complete, clean up the objects on the batteries and the surrounding area.

CAUTION

- Do not connect two or more cables to the positive or negative power port of a battery in parallel.
- Stay away from the equipment when preparing cables to prevent cable scraps from entering the equipment. Cable scraps may cause sparks and result in personal injury and equipment damage.

NOTE

The cable colors shown in the electrical connection diagrams provided in this chapter are for reference only. Select cables in accordance with local cable specifications (green-and- yellow cables are only used for PE).

6.1 Preparing Cables

Figure 6-1 Battery cable connections

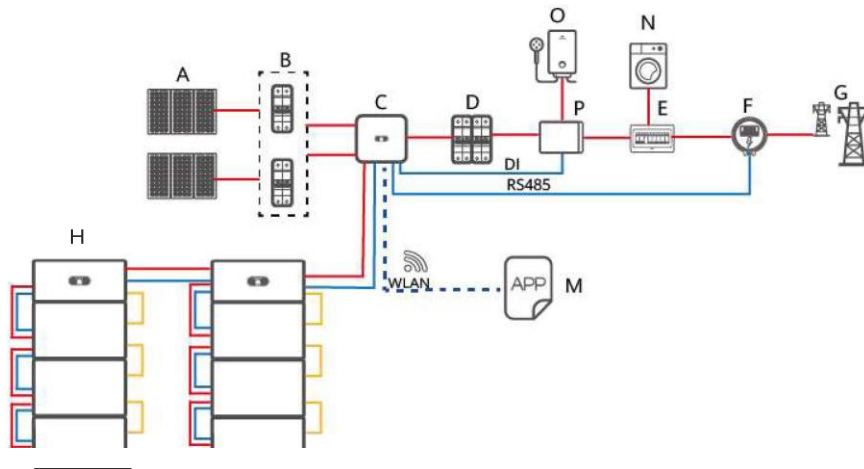

1801N10007

- | | | |
|----------------|-----------------|----------------------------|
| (A) PV string | (B) DC switch | (C) Power Shifter inverter |
| (D) AC switch | (E) ACDU | (F) Smart Power Sensor |
| (G) Power grid | (H) Power Saver | (M) FusionSolar app |

(I) Load

(O) Important Load

(P) Backup

[O] NOTE

The Power Saver batteries can be used only with DTSU666-HW, YDS60-80, DDSU666-H and DTSU666-H meters.

Table 6-1 Cables prepared by the customer

No.	Cable	Type	Recommended Specifications	Source
1	DC input power cable (inverter to battery and battery to battery)	Common outdoor PV cable in the industry	<ul style="list-style-type: none"> Conductor cross-sectional area: 4–6 mm² Cable outer diameter: 5.5–9 mm 	Prepared by the customer
2	Signal cable (inverter to battery and battery to battery)	Outdoor shielded twisted pair cable (8 cores)	<ul style="list-style-type: none"> Conductor cross-sectional area: 0.20–1 mm² Cable outer diameter: 6.2–7 mm 	Prepared by the customer
3	Ground cable	Single-core outdoor copper cable	<ul style="list-style-type: none"> 10 mm² 	Prepared by the customer

Table 6-2 Cables delivered with the battery

No.	Cable	Type	Source
1	DC input power cable (power control module to battery expansion module)	Common outdoor PV cable in the industry	Delivered with the product
2	Signal cable (power control module to battery expansion module)	Outdoor shielded twisted pair cable	Delivered with the product

No.	Cable	Type	Source
3	Ground cable	Single-core outdoor copper cable	Delivered with the product

NOTE

- --- indicates a power cable, --- indicates a signal cable, •-----• indicates wireless communication, --- indicates a ground cable.
- The minimum cable diameter must comply with local cable standards.
- The factors that affect cable selection include the rated current, cable type, routing mode, ambient temperature, and maximum expected line loss.
- The DC input power cable and signal cable between the battery and the inverter must be less than or equal to 10 m.

6.2 Internal Electrical Connections of the Battery

NOTE

Internal cables are delivered with the battery. For details, see the *Packing List* in the packing case.

6.2.1 Installing an Internal Ground Cable

Precautions

A DANGER

Ensure that the PE cable is securely connected. Otherwise, electric shocks may occur.

NOTE

It is recommended that silica gel or paint be used around the ground terminal after the PE cable is connected.

- Step 1** Connect the PE cable to the battery power control modules and battery expansion modules.

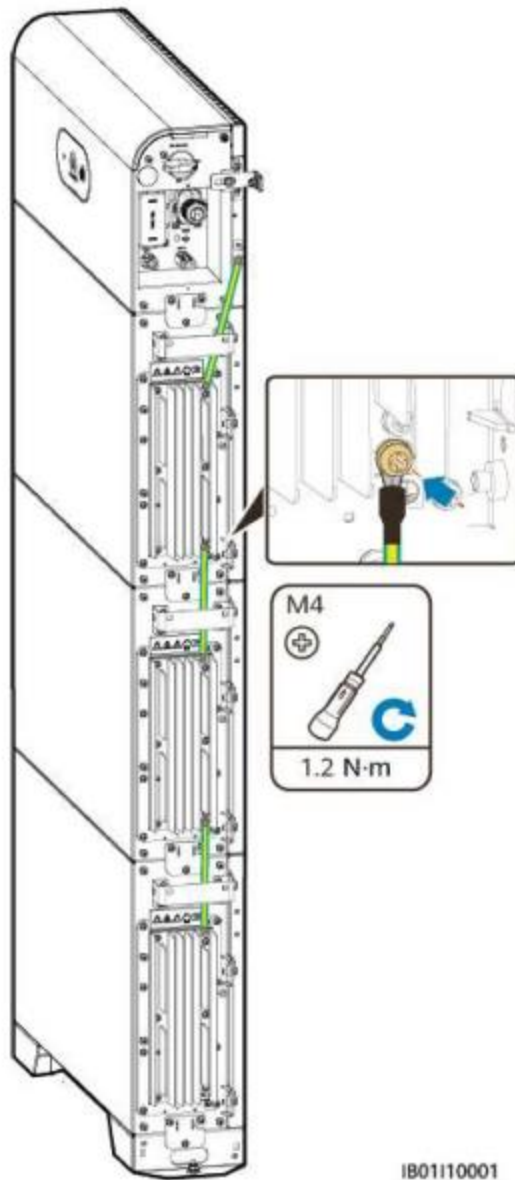
Figure 6-2 Connecting the internal PE cable

IB01110001

Figure 6-2 Connecting the internal PE cable

----End

6.2.2 Installing Internal DC Terminals

- Step 1** Insert the positive and negative connectors delivered with the battery into the positive and negative battery cascading terminals (B+ and B-).

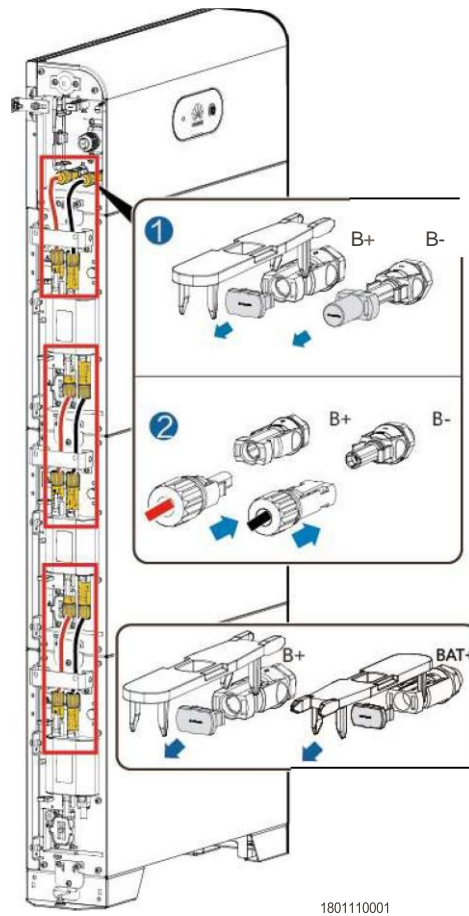
Figure 6-3 DC power cable connection inside the battery**OJ NOTE**

The DC terminals between the power control module and the battery expansion modules use the DC connection cable (Amphenol terminal) delivered with the battery.

NOTICE

After the positive and negative connectors snap into place, pull the DC input power cables back to ensure that they are connected securely.

---End

6.2.3 Connecting Internal Signal Cables

Connecting Signal Cables Between the Power Control Module and Battery Expansion Modules

DJ NOTE

- The protective housing of the communications terminal delivered with the device can be fastened with clips or screws based on the actual diagram.
- Connect the communications terminals of the power control module and battery expansion modules in sequence and secure them using cable clips. Install the internal signal cables described in this section using the three signal cables with a diameter of 5 mm and rubber plugs delivered with the DCDC. Do not use signal cables with a diameter of 7 mm. Do not install a cable with a diameter of 5 mm into a $\phi > 7$ mm rubber plug, the 7 mm hole is used to connect to an inverter or cascaded battery.

Figure 6-4 Securing With Clips

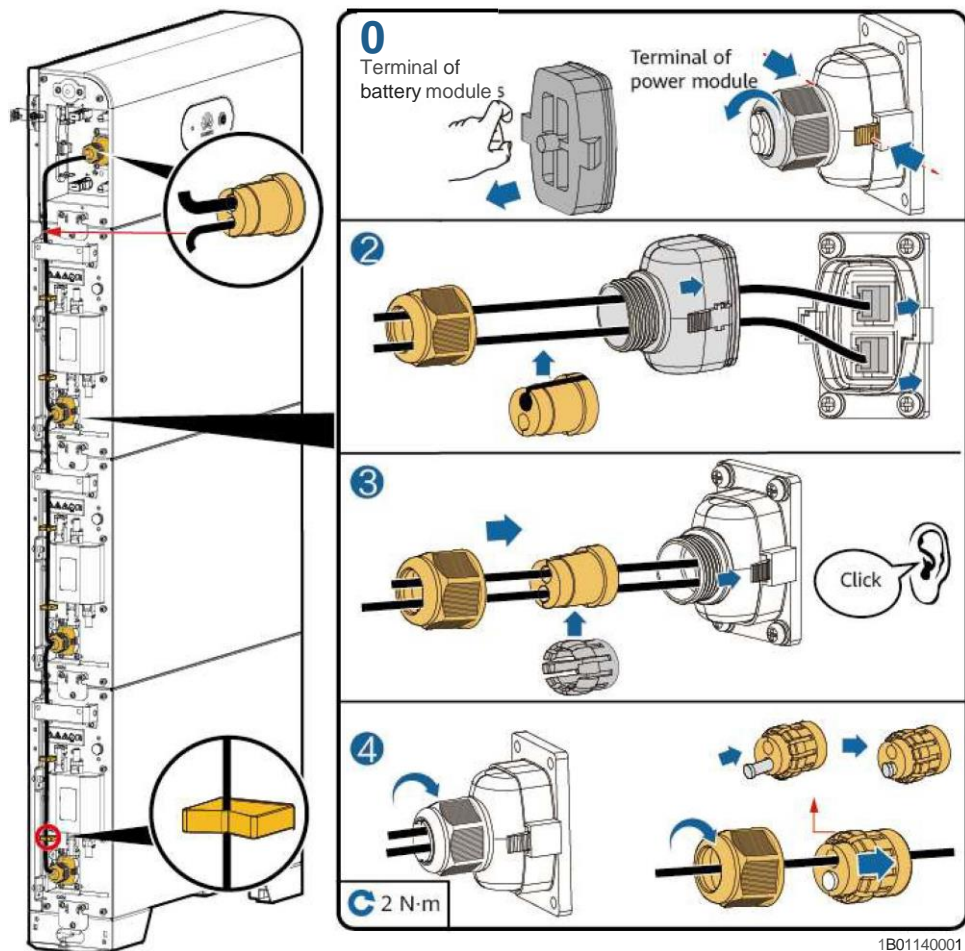
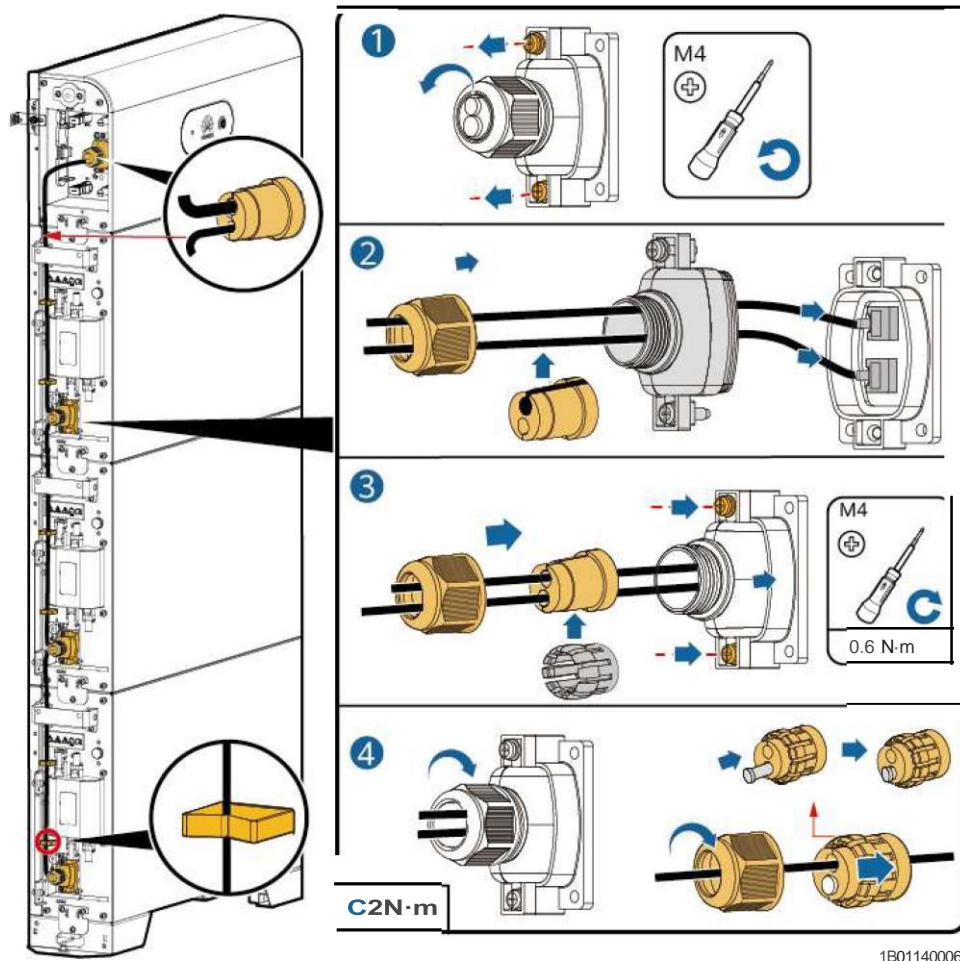

Figure 6-5 Securing With Screws



1B01140006

CO NOTE

- When a communications terminal is connected to a single network cable, a waterproof rubber plug must be installed. Do not install a cable with a diameter of 5 mm into a <1>7 mm rubber plug.
- After inserting the terminal shell into the COM port, shake the terminal shell left and right and pull it back to ensure that it is securely installed, and tighten the nut (ensure that the rubber plug is tightly compressed). Otherwise, the waterproof performance is affected.

6.3 External Electrical Connections of the Battery

Battery cable connections

NOTE

The DC-DC converter has a COM port on both sides. When batteries are connected in parallel, you are advised to connect the inverter to the COM port on the right side and connect the cascaded batteries to the COM port on the left side.

NOTICE

The COM ports on the two sides of the DC-DC converter are symmetrical and in different directions. Insert the cables to the COM ports in the directions shown in the figure.

Figure 6-7 Power Shifter 6/8/10kW

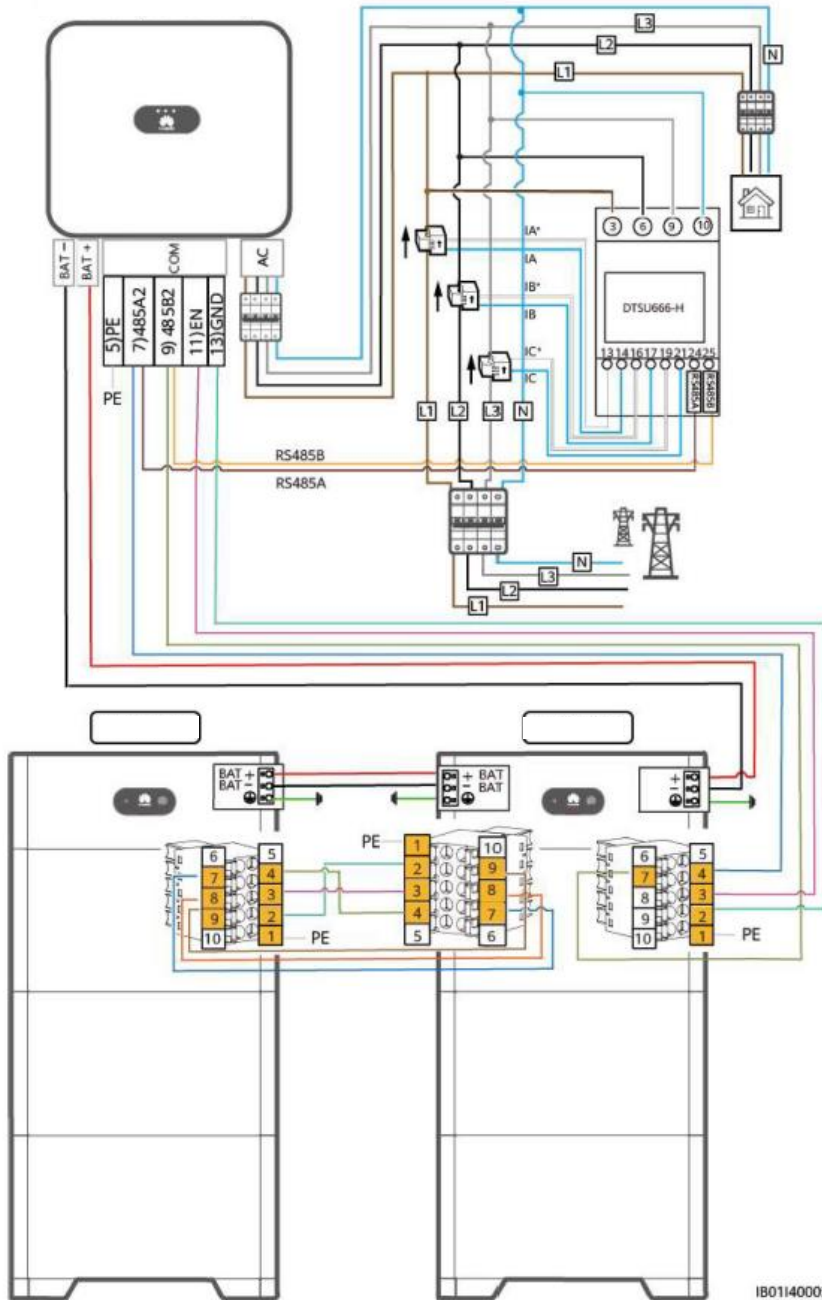

Routing Cables Out of the Cable Hole

Cut a cable hole based on the cabling mode, and route external cables through the cable hole.

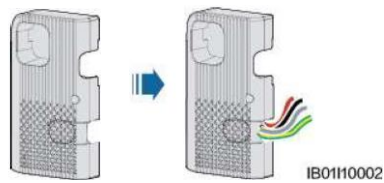
Figure 6-8 Routing cables out of the cable hole

NOTICE

Before connecting external cables, route the cables through the cable hole to avoid disconnecting after installation.

6.3.1 Installing a PE Cable

Precautions

A DANGER

Ensure that the PE cable is securely connected. Otherwise, electric shocks may occur.

NOTE

It is recommended that silica gel or paint be used around the ground terminal after the PE cable is connected.

Procedure

Step 1 Crimp an OT terminal.

NOTICE

- Avoid scratching the core wire when stripping a cable.
 - The cavity formed after the conductor crimp strip of the OT terminal is crimped must wrap the core wires completely. The core wires must contact the OT terminal closely.
 - Wrap the wire crimping area with heat shrink tubing or insulation tape. The heat shrink tubing is used as an example.
 - When using a heat gun, protect the equipment from being scorched.
-

Figure 6-9 Crimping an OT terminal

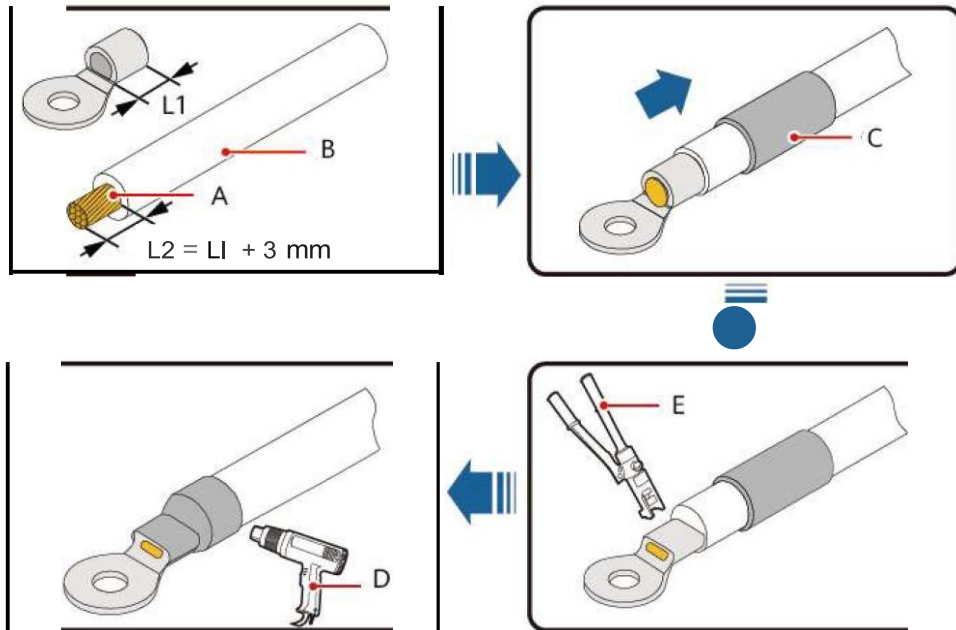

ISOSZ00001

- (A) Core wire
- (B) Insulation layer
- (C) Heat shrink tubing
- (D) Heat gun
- (E) Hydraulic pliers

Step 2 Connect the ground point of the power control module to the external ground point.

Figure 6-10 Grounding the PE cable

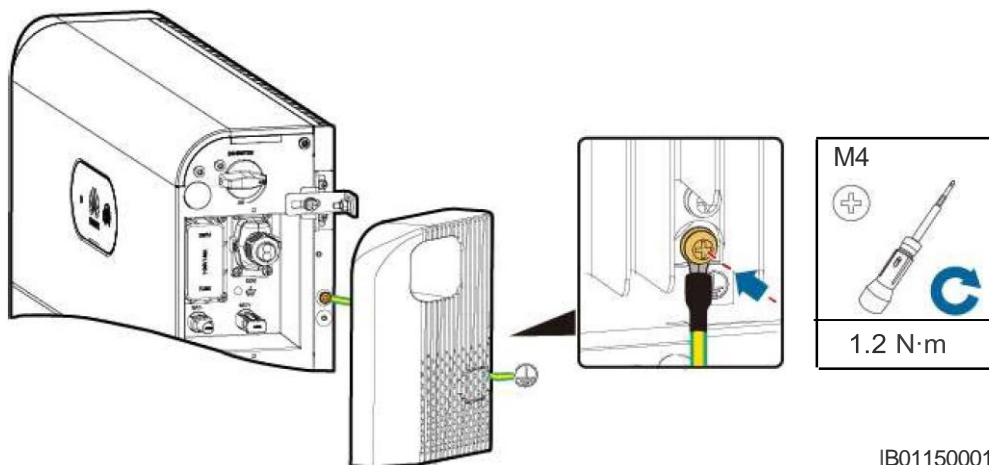

IB01150001

NOTE

- It is recommended that silica gel or paint be used around the ground terminal after the PE cable is connected.

----End

6.3.2 Installing DC Input Power Cables

Connect DC input power cables to the inverter

Insert the positive and negative battery connectors (Staubli) into the corresponding DC input terminals (BAT+ and BAT-).

[O] NOTE

The DC input terminals (BAT+ and BAT-) on the left and right sides of the battery are the same.

Step 1 Assemble DC connectors.

Figure 6-11 Assembling DC connectors

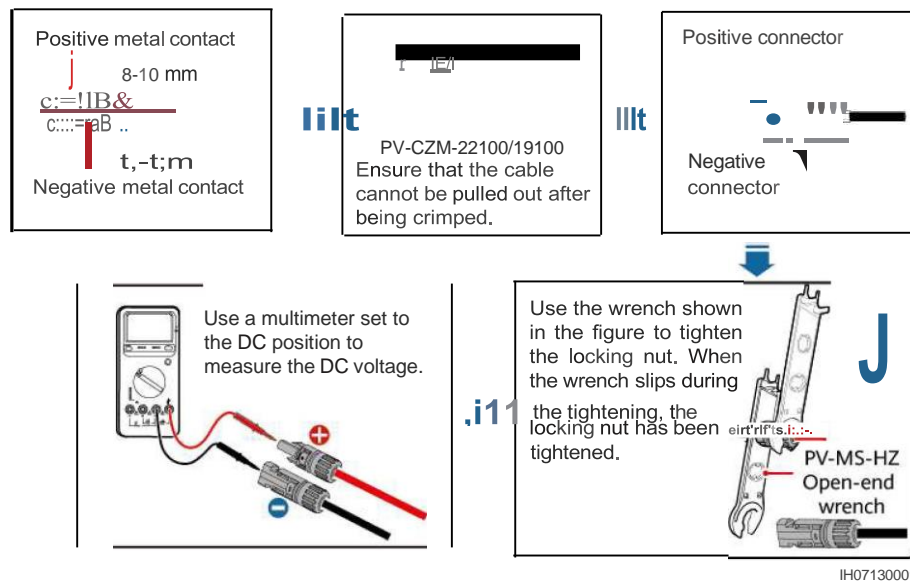
**CAUTION**

For battery terminals, use the delivered Staubli MC4 positive and negative metal terminals and DC connectors. Using incompatible positive and negative metal terminals and DC connectors may burn the cables or damage the module. The resulting device damage will not be covered under warranty.

NOTICE

- Keep the DC input BAT+ cable and BAT- cable close to each other.
- Cables with high rigidity, such as armored cables, are not recommended as DC input power cables to avoid cable folding.
- Before assembling DC connectors, label the cable polarities correctly to ensure correct cable connections.
- After crimping the positive and negative metal terminals, pull the DC input power cables back to ensure that they are connected securely.
- Insert the crimped metal terminals of the positive and negative power cables into the appropriate positive and negative connectors. Then pull back the DC input power cables to ensure that they are connected securely.

Step 2 Insert the positive and negative connectors into the battery terminals (BAT+ and BAT-) on the switch and connect the other end to the cascaded battery.

Figure 6-12 Connecting battery cables

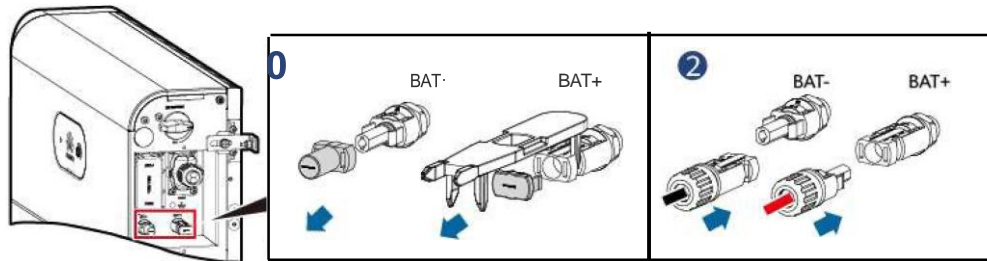

IB01130001

----End

6.3.3 Installing a Signal Cable

Connecting the Signal Cable between the Power Control Module and the Inverter

NOTICE

When laying out a signal cable, separate it from power cables and keep it away from strong interference sources to prevent communication interruption.

The COM port definitions on both sides of the power control module are the same. It is recommended that the COM port on the switch side be connected to the inverter and the COM port on the other side be connected to the cascaded battery.

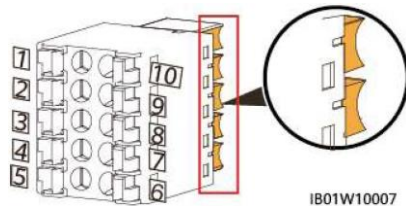
Figure 6-13 Signal cable ports**Table 6-3** COM port definition

No.	Label	Definition	Description
1	PE	Shield layer grounding	Shield layer grounding
2	Enable-	Enable signal GND	Connects to the enable signal GND of the inverter.
3	Enable+	Enable signal+	Connects to the positive enable signal of the inverter.
4	485A	RS485A, RS485 differential signal+	Connects to the RS485 signal port+ of the inverter or cascaded battery.
5			
6	485B	RS485B, RS485 differential signal-	Connects to the RS485 signal port - of the inverter or cascaded battery.
7			
8	CANL	Extended CAN bus port	Used for signal cable cascading in battery cascading scenarios.
9	CANH	Extended CAN bus port	Used for signal cable cascading in battery cascading scenarios.
10	PE	Shield layer grounding	Shield layer grounding

Terminals

NOTE

- Identify the signal terminal pins according to the following figures, and connect cables according to **Table 6-3**. When you insert the communications terminal of the power control module, the silk screens on the two sides of the communications port are different. Insert the communications terminal according to the following figures.
- The communications terminals on the inverter side need to be connected to RS485+ \RS485-, EN+ \EN-, and PE.

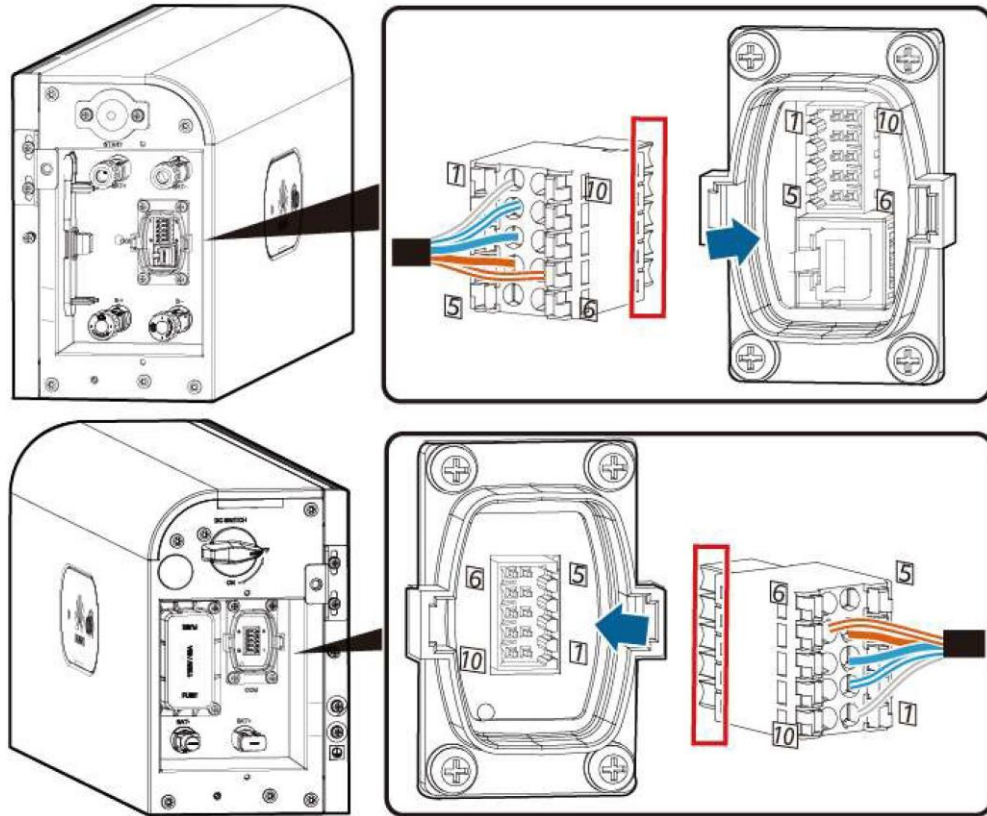
Figure 6-14 Inserting the terminal

IB01W10008

Connecting a Signal Cable

Prepare signal cable terminals for connecting to the inverter.

Figure 6-15 Connecting inverter terminals

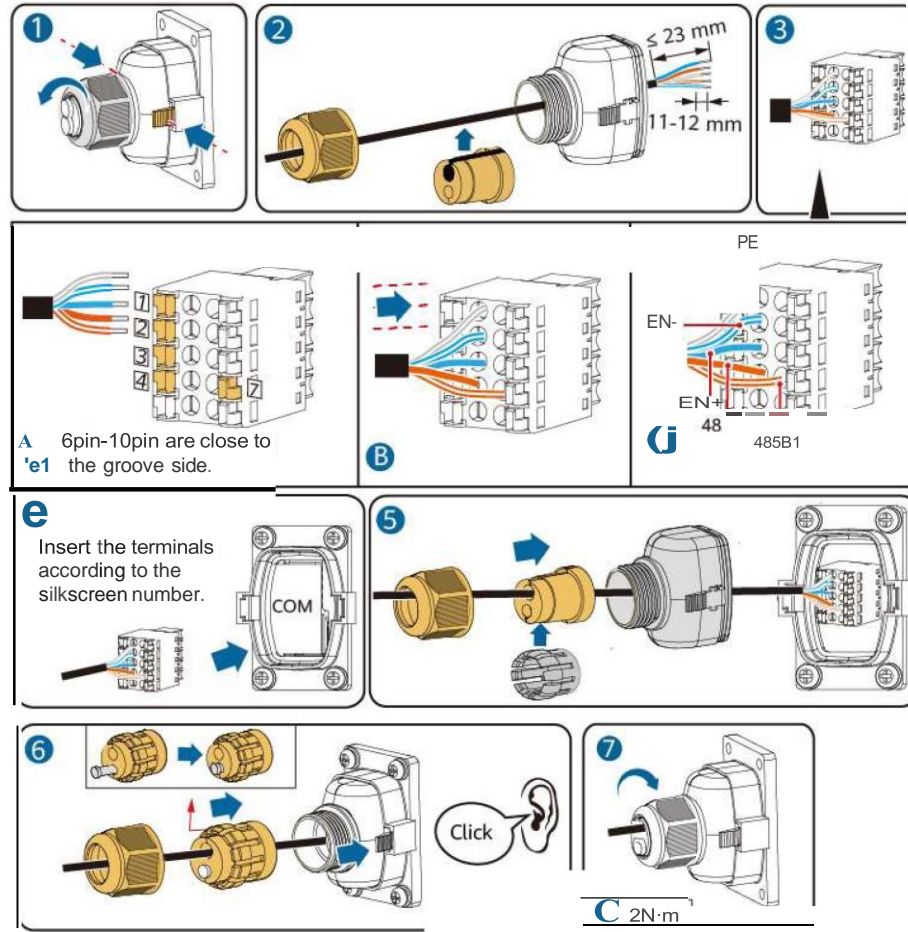

IB01140002

6.4 (Optional) Cascading Batteries

Battery Cascading Cable Connection

Figure 6-16 Battery cascading cable connection

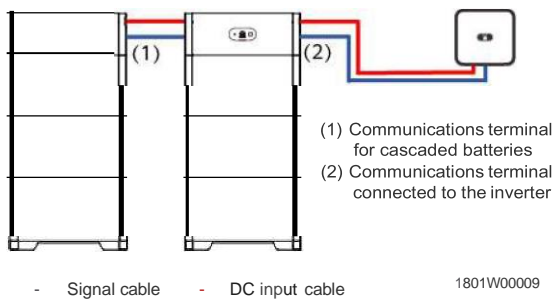

Connecting Cascading DC Input Power Cables (Cascading)

Connect the DC input terminals (BAT+ and BAT-) between the power control module by referring to [6.3.2 Installing DC Input Power Cables](#).

Terminals

[O NOTE

- Identify the signal terminal pins according to the following figures, and connect cables according to [Table 6-3](#). When you insert the communications terminal of the power control module, the silk screens on the two sides of the communications port are different. Insert the communications terminal according to the following figures.
- The communications terminals on the cascading side need to be connected to RS485+ \RS485-, EN+ \EN-, CANH \CANL, and PE.

Figure 6-17 Inserting the terminal

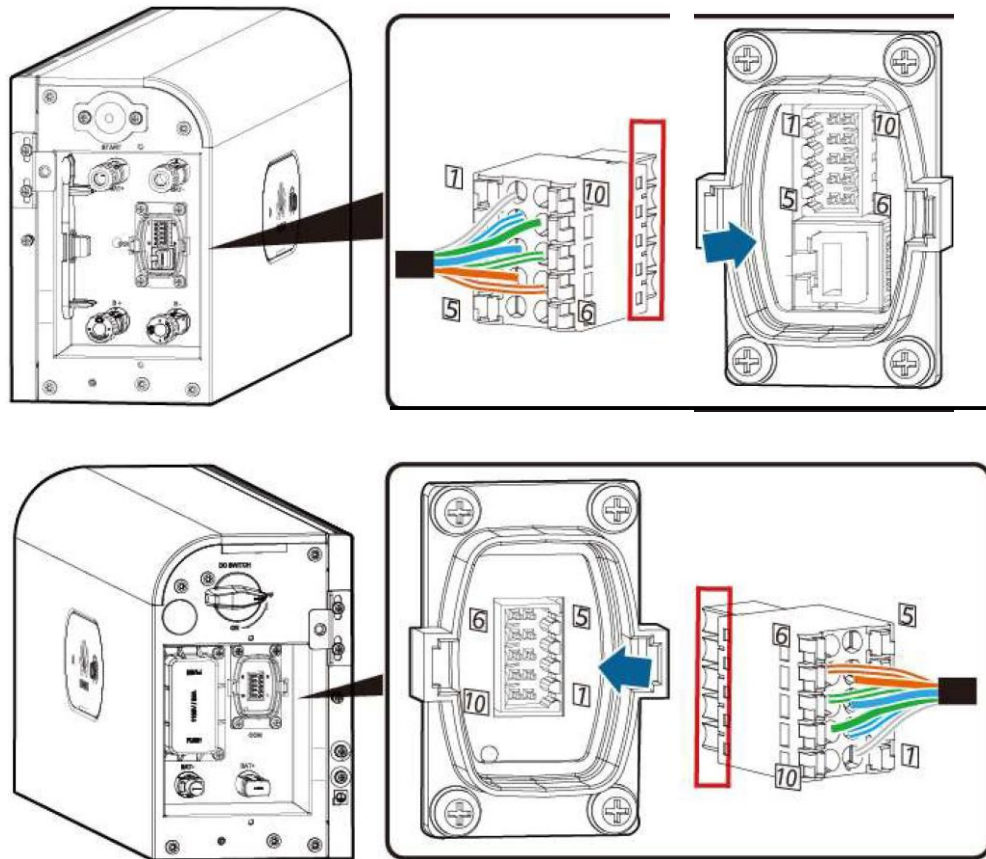

1B01W10008

Connecting a Signal Cable (Cascading)

Prepare a signal cable terminal for connecting the power control module.

Figure 6-18 Cascading communication terminal

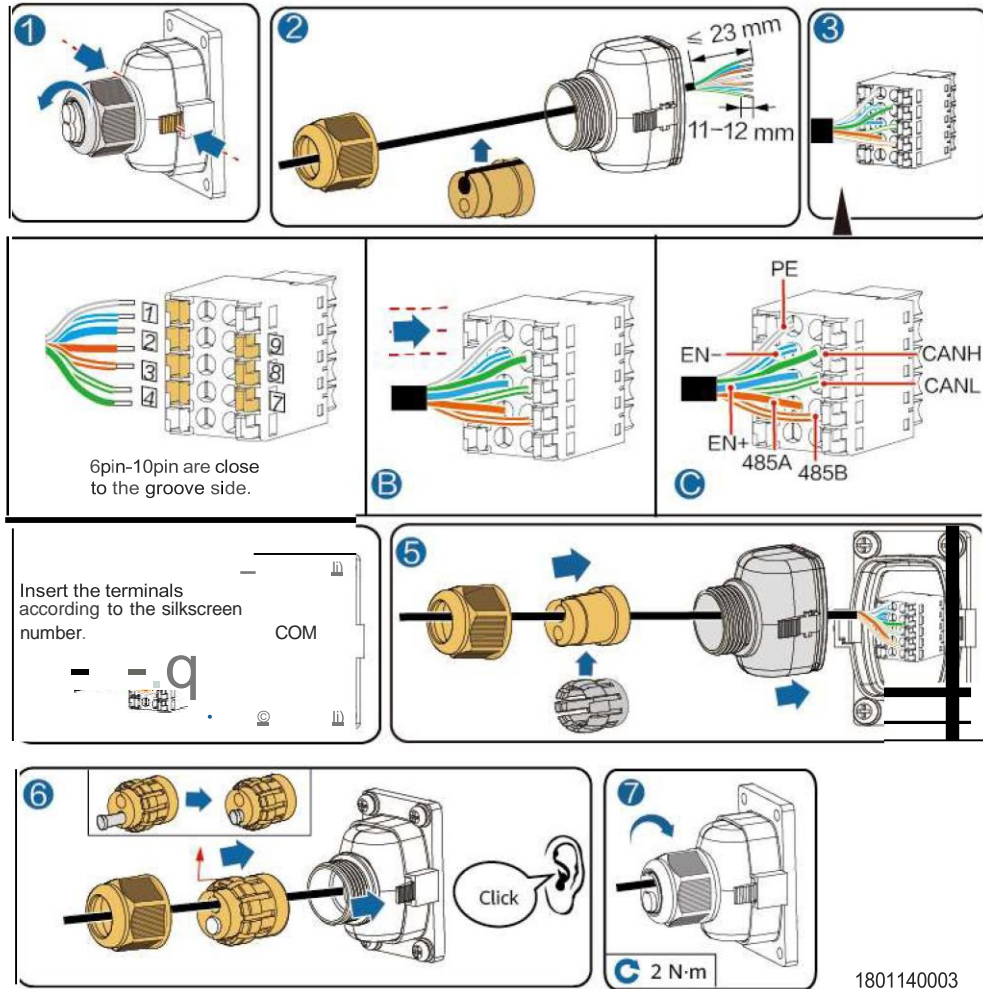

6.5 Installing the Cover

After electrical connections are complete, check that cables are correctly and securely connected, install the external protective cover, and secure it using screws.

Figure 6-19 Installing the cover

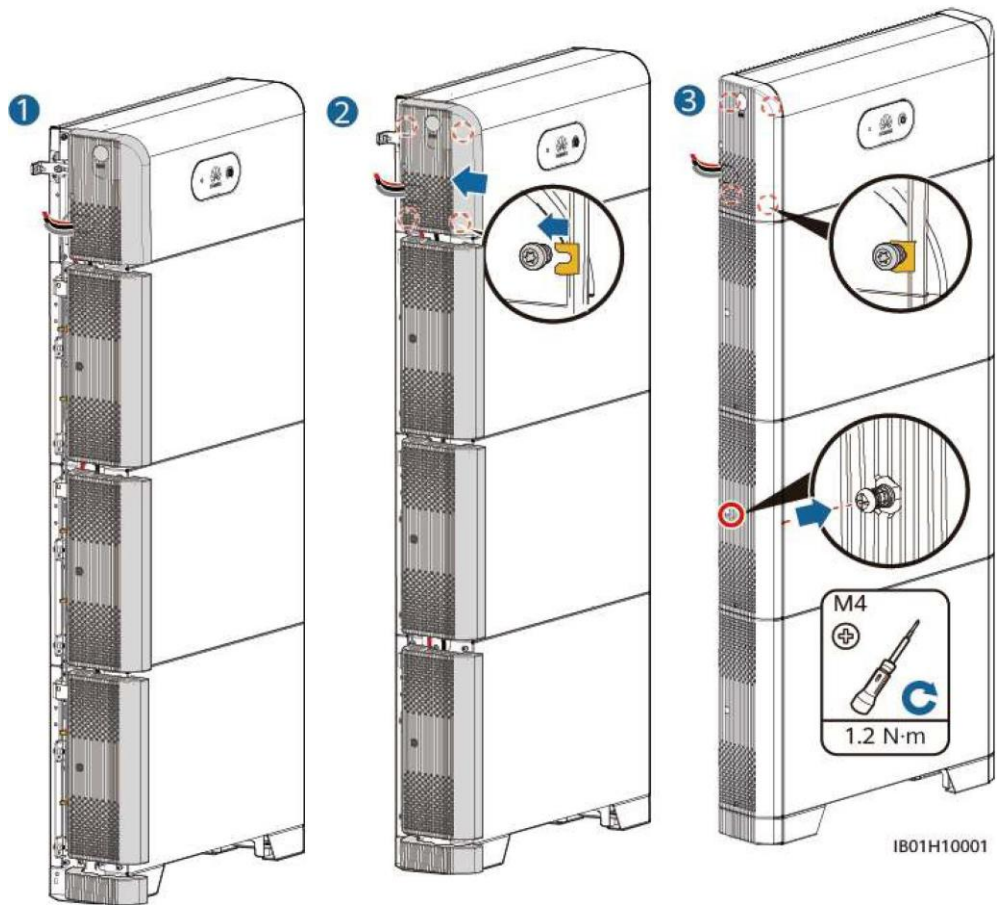

7 System Commissioning

DANGER

- Wear personal protective equipment and use dedicated insulated tools to avoid electric shocks or short circuits.

CAUTION

- During the power-on procedure, power off the batteries immediately if any fault is detected. Rectify the fault before proceeding with the procedure.
- After batteries are used for system commissioning or batteries have discharged, charge the batteries in time. Otherwise, batteries may be damaged due to overdischarge.
- Battery overdischarge and damage may occur if batteries with low SOC are stored. Batteries should be recharged in a timely manner.

NOTICE

Before the equipment is put into operation for the first time, ensure that the parameters are set correctly by professional personnel. Incorrect parameter settings may result in noncompliance with local grid connection requirements and affect the normal operations of the equipment.

7.1 Verification Before Power-On

Table 7-1 Check items and acceptance criteria

No.	Check Item	Acceptance Criteria
	Battery installation	The installation is correct and reliable.

	Check Item	Acceptance Criteria
2	Cables routing	Cables are routed properly as required by the customer.
3	Cable tie	Cable ties are evenly distributed and no burr exists.
4	Grounding	The PE cable is connected correctly, securely, and reliably.
5	Switch	The DC switch and all switches connected to the battery are OFF.
6	Cable connection	The AC output power cable, DC input power cable, battery cable, and signal cable are connected correctly, securely, and reliably.
7	Unused terminal and port	Unused terminals and ports are locked by watertight caps.
8	Installation environment	The installation space is proper, and the installation environment is clean and tidy.

7.2 System Power-On

NOTICE

- Power on the Power Saver within 24 hours after unpacking. The power-off time cannot exceed 24 hours during maintenance.
- After turning on the battery switch, power on the inverter. For details about how to power on the inverter, see the quick guide for the corresponding inverter model.



[O] NOTE

If no PV module is configured, press the black start button first.

Turn on the DC switch on the battery. After the battery is installed and powered on for the first time, the ring LED blinks for three circles. Observe the battery indicator to check the running status.

LED Indicators

Table 7-2 LED indicators

Category	Status (Blinking at Long Intervals: On for 1s and then Off for 1s; Blinking at Short Intervals: On for 0.2s and then Off for 0.2s)		Description
Running indicator			N/A
	Steady green	Steady green	Operating mode
	Blinking green slowly	Blinking green slowly	Standby mode
	Off	Off	Hibernation mode
	Blinking red fast	N/A	Power control module environment alarm
	N/A	Blinking red fast	Battery expansion module environment alarm
	Steady red	N/A	The power control module is faulty.
	N/A	Steady red	The battery expansion module is faulty.
Battery system indicator			N/A
	Green		Battery level. Each bar indicates 10%.
	Steady red		The first three bars indicate the number of faulty battery expansion modules.

7.3 Battery Commissioning

Download and install the FusionSolar app

- Method 1: Access <https://solar.huawei.com> using the mobile phone browser and download the latest installation package.

Figure 7-1 Download Mode

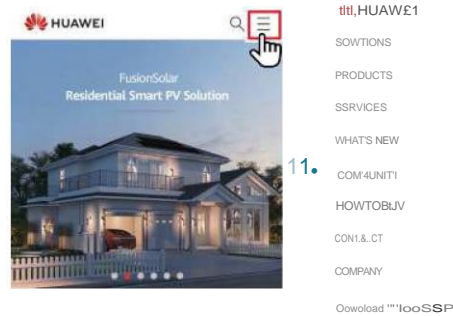

- Method 2: Search for FusionSolar on Huawei AppGallery and download the latest installation package.
- Method 3: Scan the following QR code and download the latest installation package.

Figure 7-2 QR code



Download and install the latest FusionSolar app by referring to the quick guide for the corresponding inverter model or the *FusionSolar App Quick Guide*. Then register the installer and create a PV plant and owner (skip this step if the account has been created). You can obtain the *FusionSolar App Quick Guide* by scanning the following QR code.

Figure 7-3 FusionSolar App Quick Guide



7.3.1 Battery Deployment

NOTE

- During system deployment, if the communications cables Enable+/Enable- are correctly connected, the Power Shifter inverter enables the battery and the indicator is on. Do not press the black start button to enable the battery. Otherwise, the communications cable connection between the Power Shifter inverter and the battery cannot be verified.
- In cascaded networking scenarios, connect an inverter equipped with energy storage devices for quick deployment.

Function

Add a battery and set the working mode on the quick settings screen of the inverter.

Scenario 1: Quick Settings for Single Inverter or Cascaded System Based on Smart Dongle Networking

- Step 1** Log in to the FusionSolar app as installer, tap **Setup Wizard**, and scan the inverter QR code (when the Smart Dongle is connected, scan the QR code of the inverter connected to the Smart Dongle).

Figure 7-4 Setup Wizard

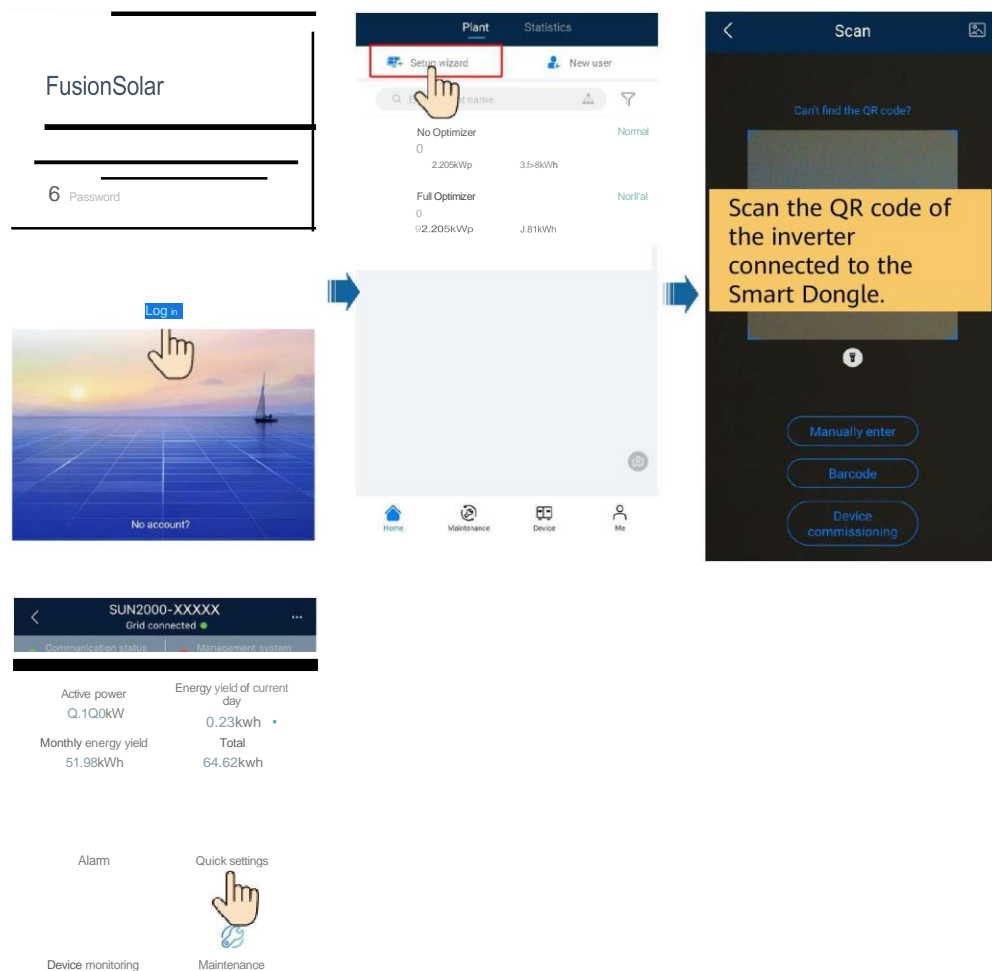

At the first login, the **Quick settings** screen is displayed by default.

- Step 2** Tap **Quick settings** to set parameters for commissioning as prompted. For details about setting the battery working mode, see [3 "Application Scenarios and Settings"](#).

Figure 7-5 Quick settings

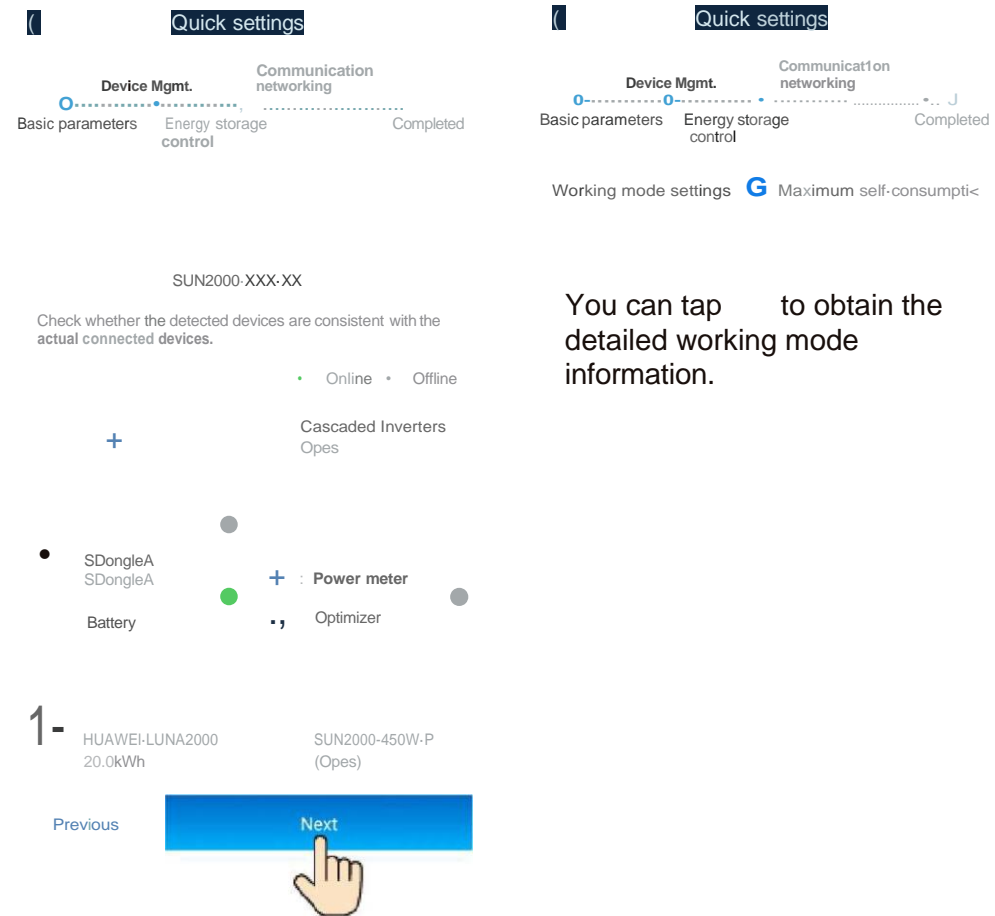

You can tap  to obtain the detailed working mode information.

---End

Adding a Power Meter Through Smart Dongle

NOTE

If a third-party inverter is connected to a meter, add the meter through the Smart Dongle after quick deployment.

- Step 1** Log in to the FusionSolar app as installer, choose **Me > Device commissioning**, and connect to the Wi-Fi of the Smart Dongle. (The Smart Dongle Wi-Fi can be found within three minutes after the Smart Dongle is powered on. If it has been powered on for more than three minutes, reconnect the Smart Dongle.)

Figure 7-6 Connecting to the Smart Dongle Wi-Fi

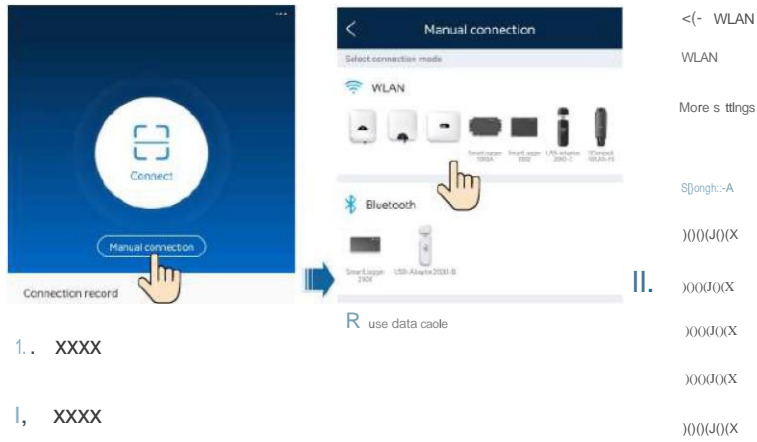

Step 2 On the home screen, choose **Maintenance > Subdevice management** and add a power meter.

Figure 7-7 Adding a power meter through Smart Dongle



I.

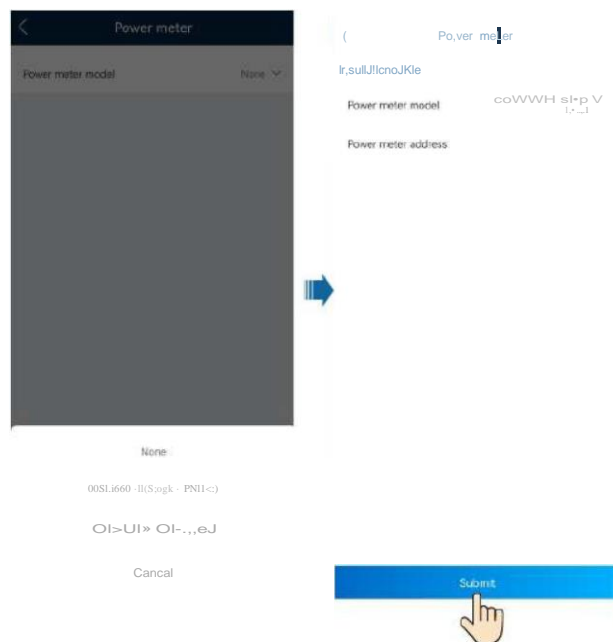

NOTE

Retain the default value for the meter address.

----End

Scenario 2: Quick Settings for Cascaded System Based on Smartlogger Networking

Step 1 Log in to the FusionSolar app as installer, tap **Setup Wizard**, and scan the Smartlogger QR code.

Figure 7-8 Setup Wizard

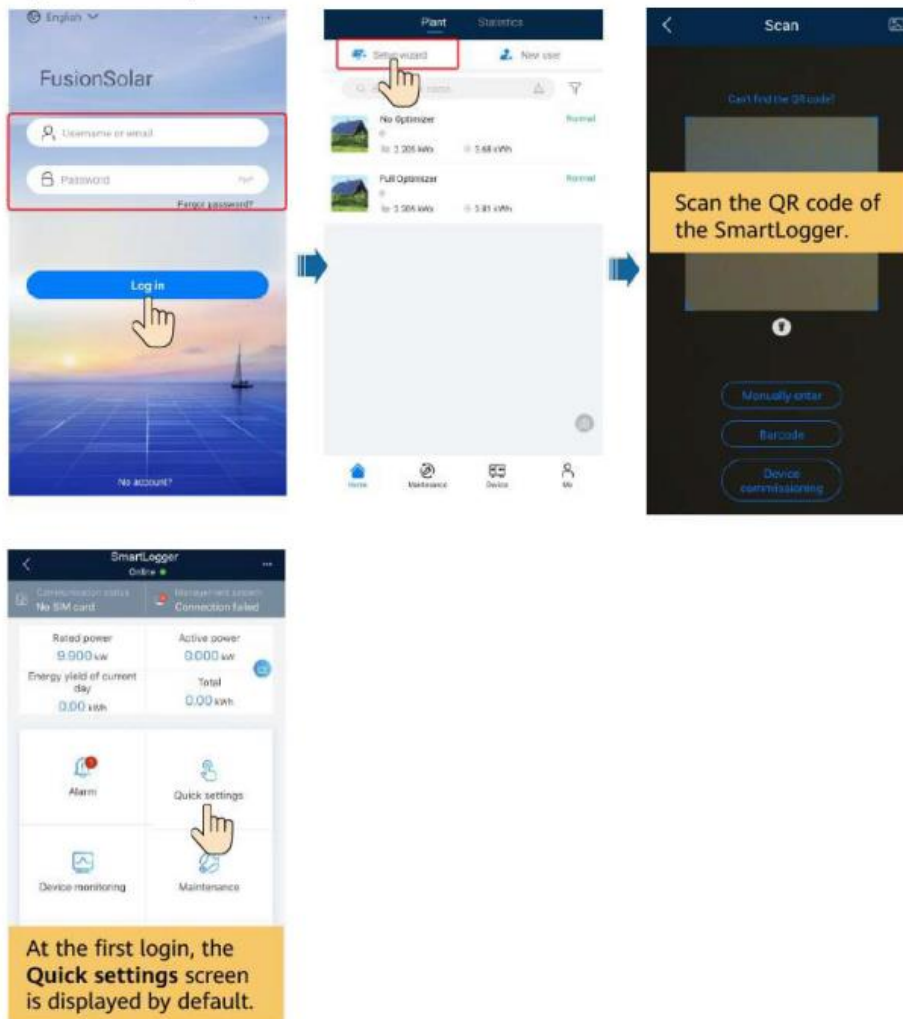

Step 2 Tap **Quick settings** to set parameters for commissioning as prompted. For details about setting the battery working mode, see **3 "Application Scenarios and Settings"**.

Figure 7-9 Quick settings

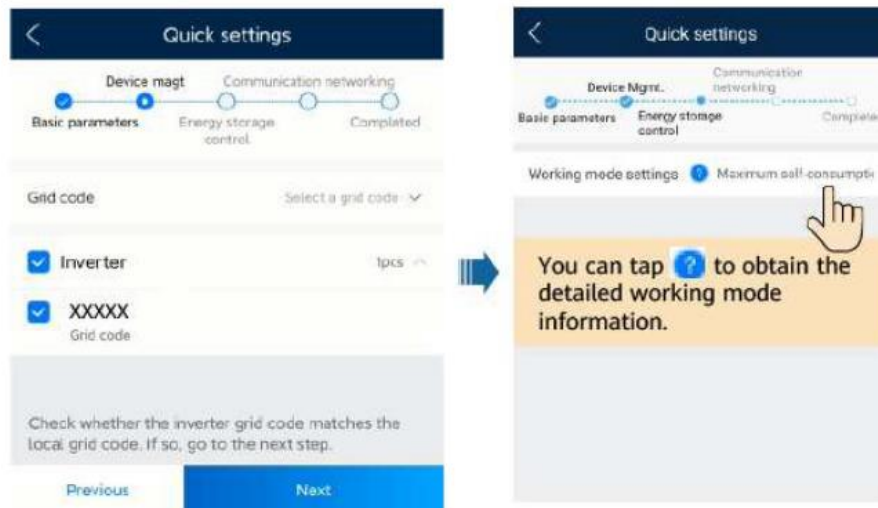

----End

7.3.2 Battery Control

Function

When the inverter connects to a battery, add the battery and set battery parameters.

Adding a Battery

To add a battery, choose **Maintenance > Subdevice management** on the home screen.

Figure 7-10 Adding a battery

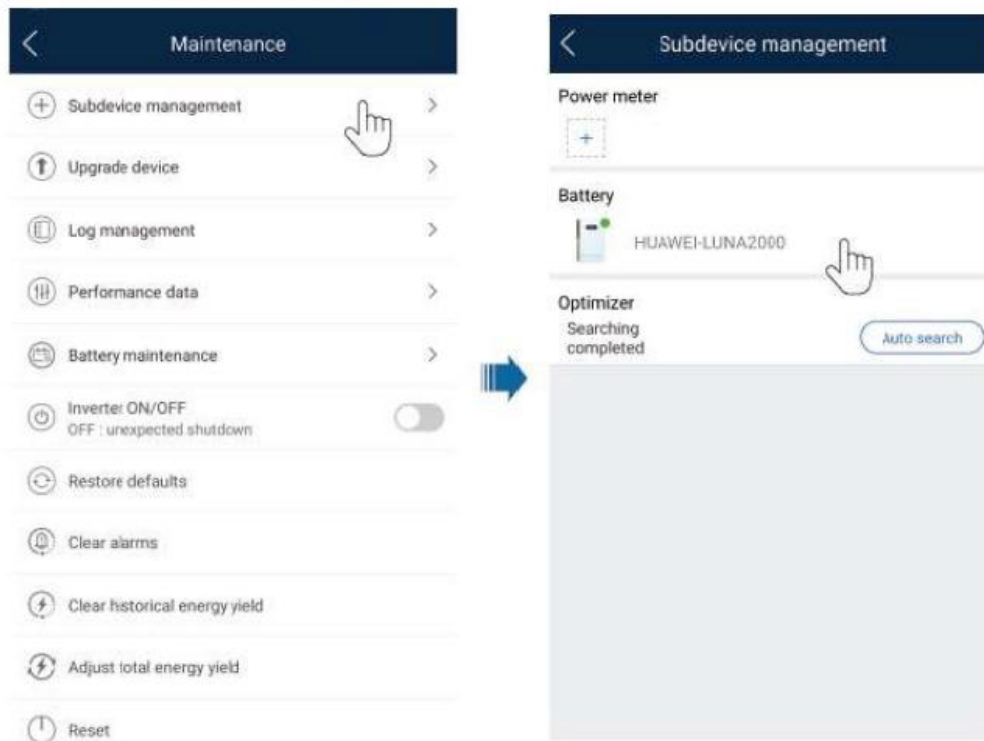

Setting Parameters (Single Inverter or Cascaded System Based on Smart Dongle Networking)

Log in to the FusionSolar app as installer, connect to the inverter, choose **Power adjustment** > **Battery control** on the home screen, and set the battery control parameters and working mode.

Figure 7-11 Battery control parameter setting

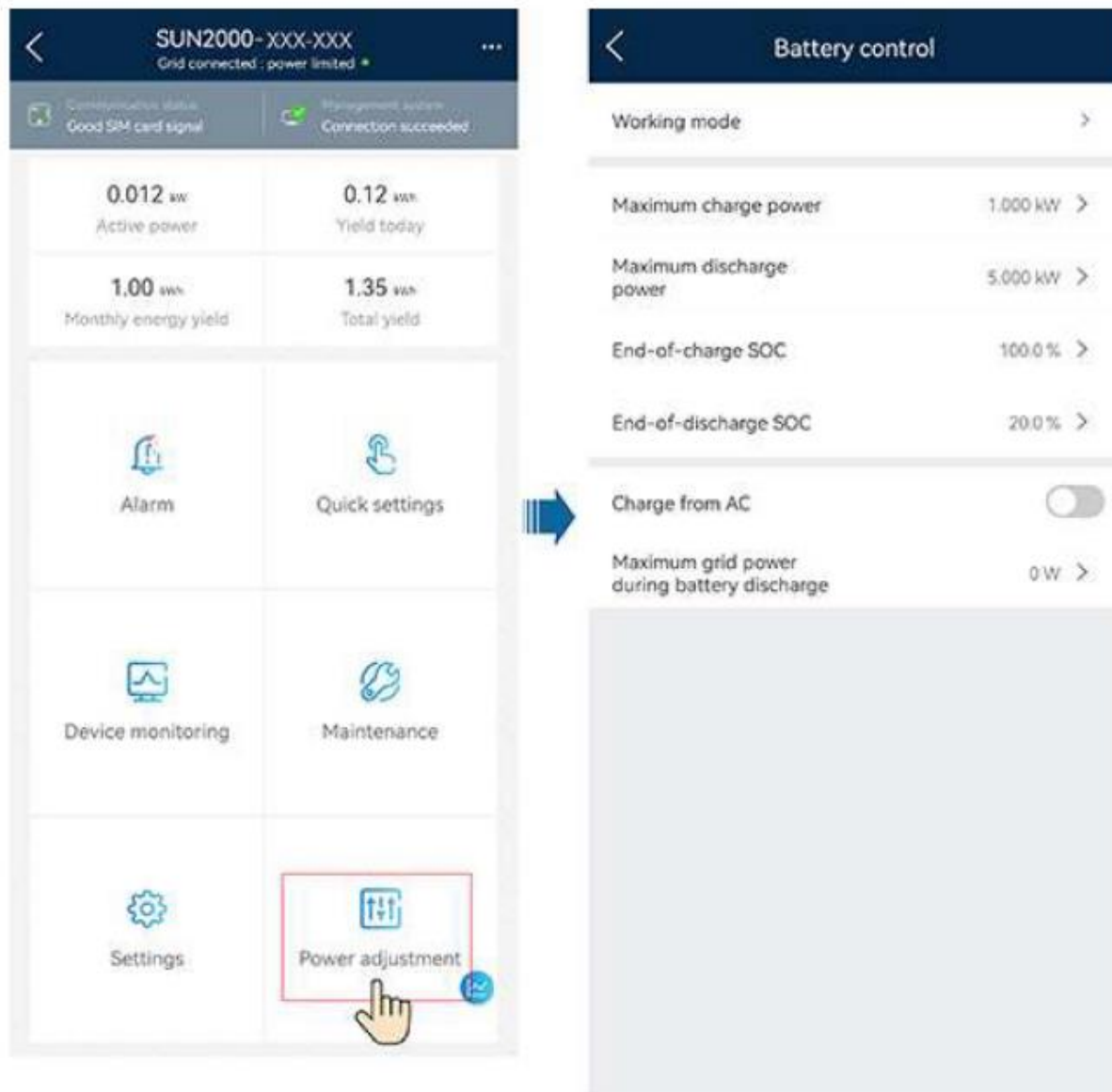

Setting Parameters {Cascaded System Based on Smartlogger Networking}

1. Log in to the FusionSolar app as installer, connect to the Smartlogger, choose **Power adjustment > Battery control** on the home screen, and set the battery working mode.

Figure 7-12 Setting the battery working mode

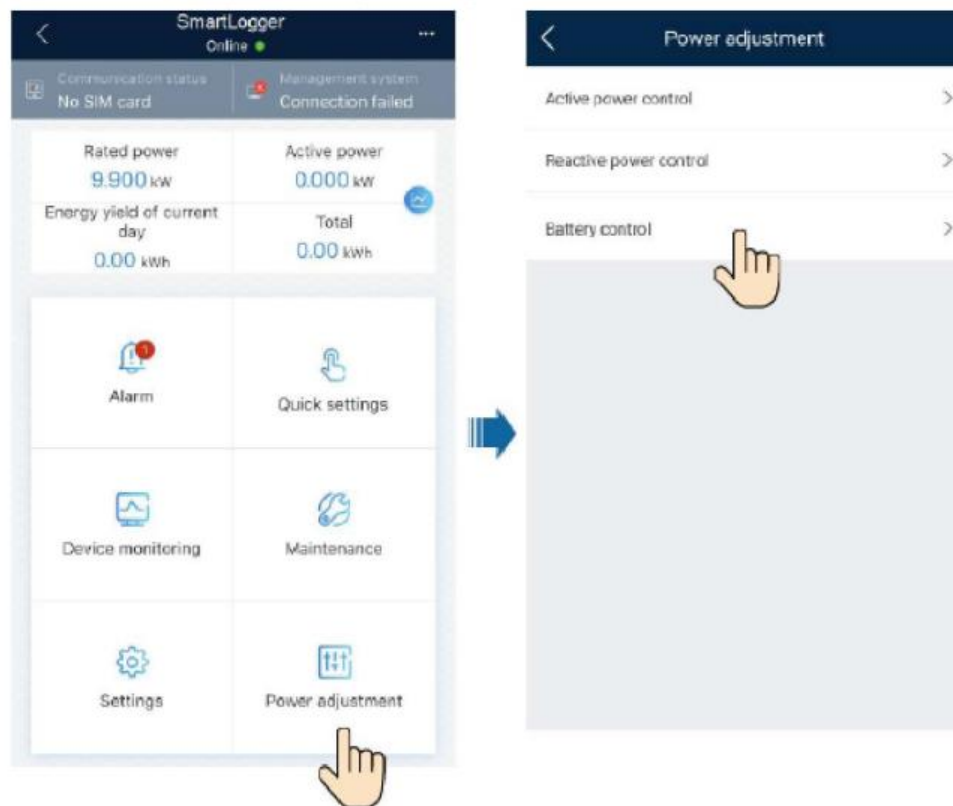

2. On the home screen, tap **Device monitoring**, select the corresponding inverter, and tap **Settings** to set the battery control parameters.

Figure 7-13 Setting the battery parameters

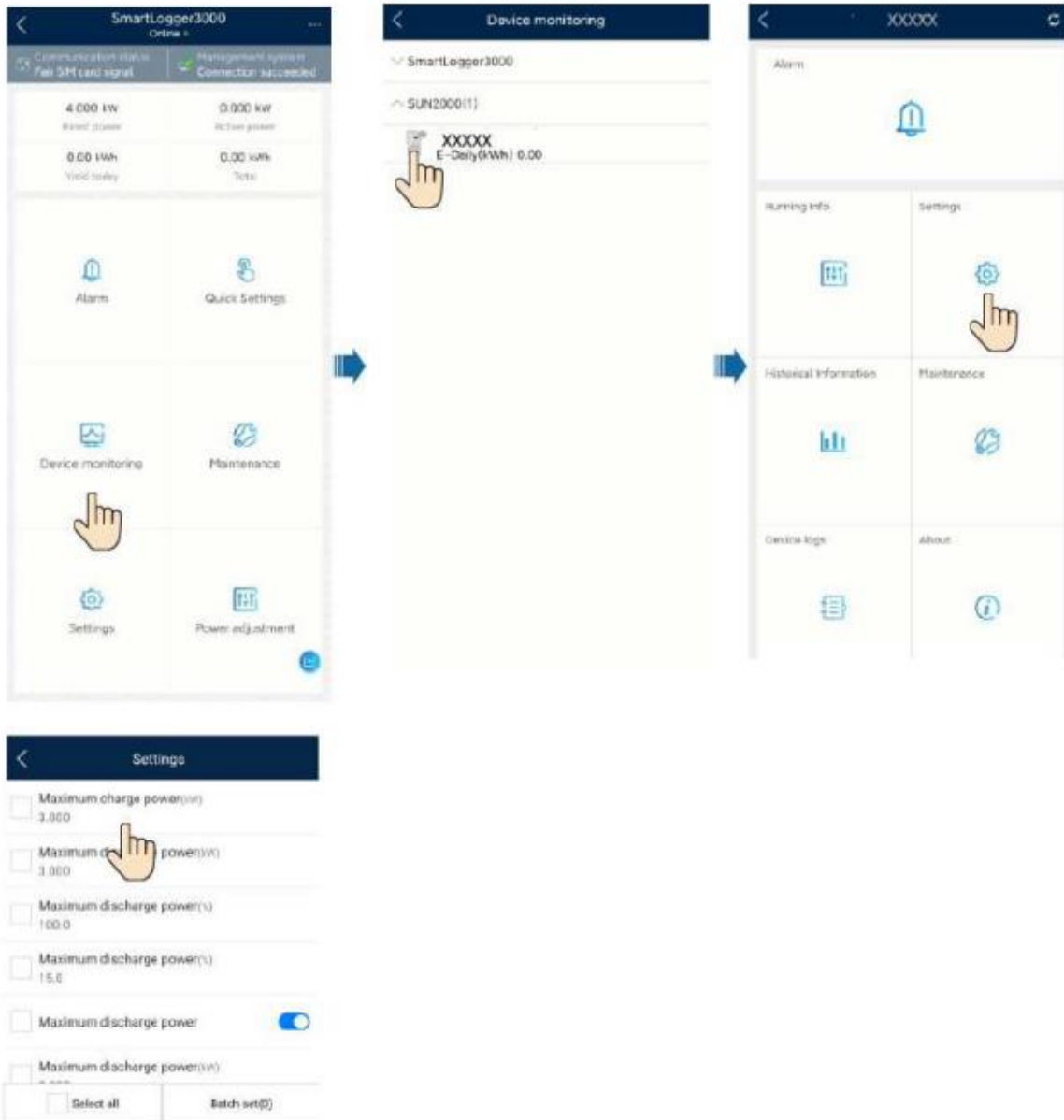

Maximum charge power (kW)	Retain this parameter to the maximum charge power. Additional configuration is not required.	Charge: [0, Maximum charge power]
Maximum discharge power (kW)	Retain this parameter to the maximum discharge power. Additional configuration is not required.	Discharge: [0, Maximum discharge power]

Parameter	Description	Value Range
End-of-charge SOC (%)	Set the charge cutoff capacity.	90%–100%
End-of-discharge SOC (%)	Set the discharge cutoff capacity.	0%–20%
Charge from grid	If Charge from grid function is disabled by default, comply with the grid charge requirements stipulated in local laws and regulations when this function is enabled.	<ul style="list-style-type: none"> • Disable • Enable
Grid charge cutoff SOC	Set the grid charge cutoff SOC.	[20%, 100%]

NOTE

If no PV modules are installed or the system has not detected sunlight for at least 24 hours, the minimum end of discharge SOC is 15%.

7.3.3 Querying the Battery Status

Scenario 1: Single Inverter or Cascaded System Based on Smart Dongle Networking

Log in to the FusionSolar app as installer, connect to the inverter, and tap **Device monitoring** on the home screen to check the running status, battery level, power, and charging and discharging status of the ESS. If an alarm is generated, see [7.3 "Troubleshooting"](#).

Figure 7-14 Device monitoring

Scenario 2: Cascaded System Based on Smartlogger Networking

Log in to the FusionSolar app as installer, connect to the Smartlogger. On the home screen, tap **Device monitoring**, select the corresponding inverter, and choose **Maintenance > Subdevice management** to check the running status, battery level, power, and charging and discharging status of the ESS. If an alarm is generated, see [7.3 "Troubleshooting"](#).

Figure 7-15 Querying the battery status

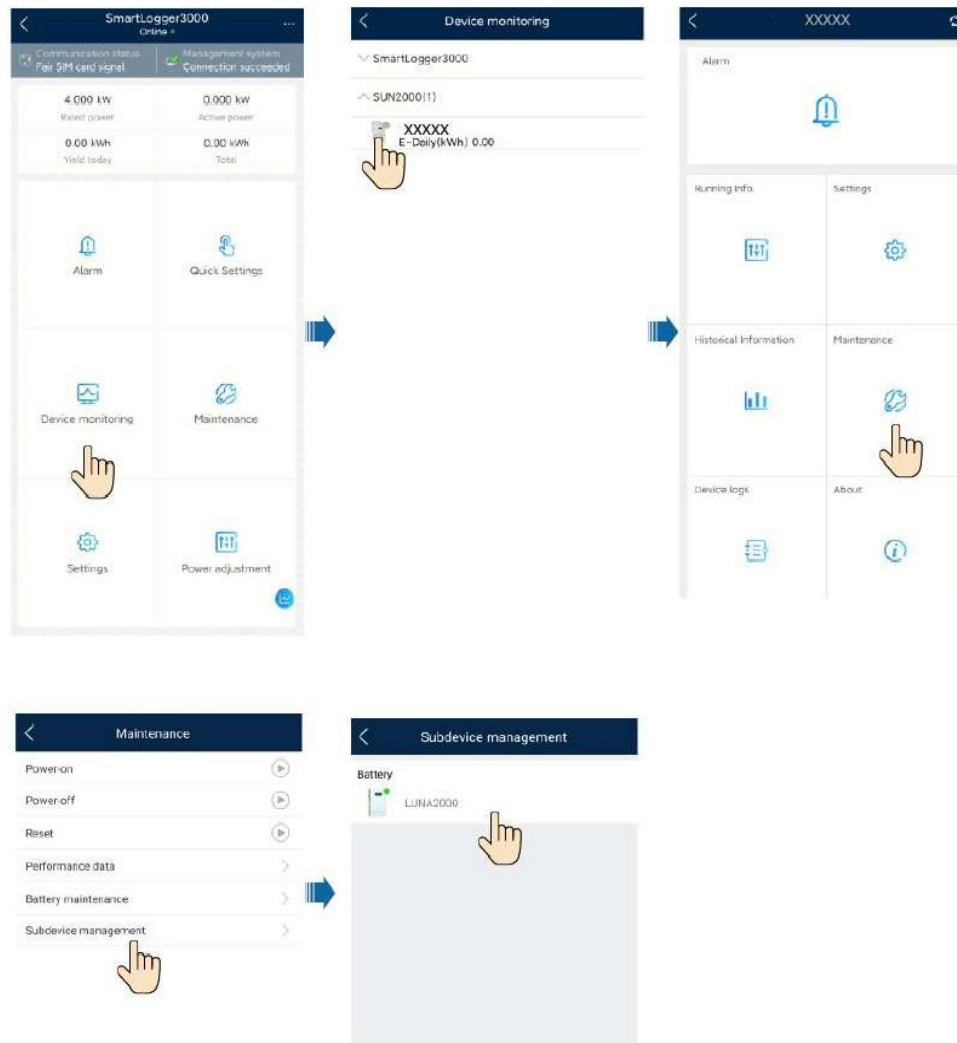

7.3.4 Battery Maintenance and Upgrade

Forced Charge and Discharge

NOTE

- For a cascaded system based on Smart Dongle networking, tap **Maintenance** on the home screen.
- For a cascaded system based on Smartlogger networking, tap **Device monitoring** on the home screen, select the corresponding inverter, and tap **Maintenance**.
- If the inverter is upgraded or reset, or the battery is upgraded or goes offline, forced charge and discharge will stop.

Step 1 Choose **Maintenance > Battery maintenance > Forced charge and discharge**, set forced charged and discharged parameters, and tap **Submit**.

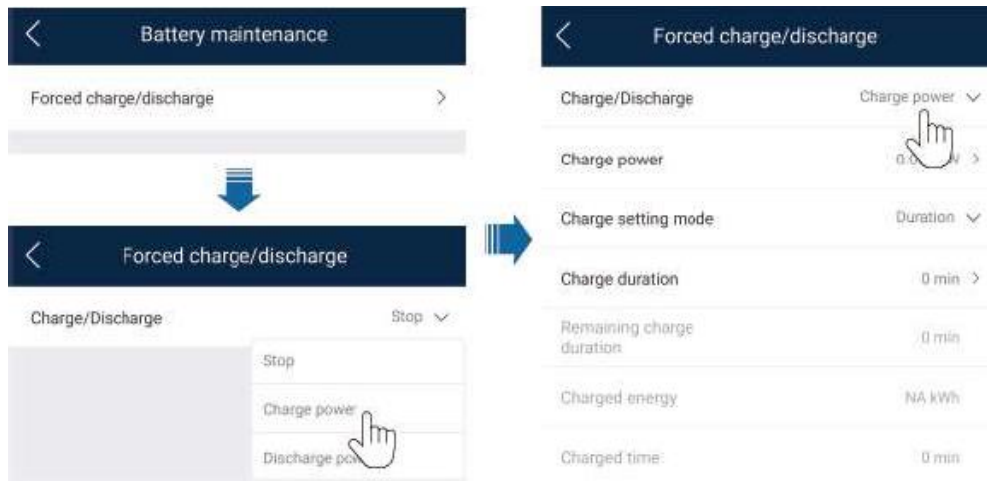
Figure 7-16 Forced Charge and Discharge**Table 7-3** Description of forced charge/discharge parameters

Parameter	Description	Value Range
Charge/Discharge	Specifies whether to charge or discharge the battery.	<ul style="list-style-type: none"> • Stop • Charge • Discharge
Charge/Discharge power (kW)	Specifies the forced charge/discharge power.	<ul style="list-style-type: none"> • Charge: [0, Maximum charge power] • Discharge: [0, Maximum discharge power]
Charge/Discharge setting mode	Set the charge and discharge mode.	<ul style="list-style-type: none"> • Duration • Charged/Discharged energy
Charge/Discharge duration (min)	Sets the charge and discharge duration.	[0, 1440]
Remaining charge/discharge duration (min)	Indicates the remaining charge and discharge duration. This parameter cannot be set.	-
Charged/Discharged energy (kWh)	Indicates the charged or discharged battery level. This parameter cannot be set.	-
Charged/Discharged duration (min)	Indicates the charged and discharged duration. This parameter cannot be set.	-

----End

Downloading an Upgrade Package

Step 1 When your phone is connected to a network, on the connection screen, tap  in the upper right corner, and then choose **File download**.

Figure 7-17 Downloading a file



Step 2 Download the device upgrade package and grid code when an update is detected.

Step 3 On the screen for downloading the upgrade package, tap **Download**.

----End

8 System Maintenance

Lt, DANGER

- Wear personal protective equipment and use dedicated insulated tools to avoid electric shocks or short circuits.
 - Do not smoke or have an open flame around batteries.
 - Do not use wet cloth to clean exposed copper bars or other conductive parts.
 - Do not use water or any solvent to clean batteries.
-

ffi WARNING

- Do not maintain batteries with power on. To power off the batteries before performing operations such as checking and tightening screw torques, explain the risks to the customer, obtain the customer's written consent, and take effective preventive measures.
 - After batteries are discharged, charge them in time to avoid damage due to overdischarge.
 - Before moving or reconnecting the equipment, disconnect the mains and batteries and wait for five minutes until the equipment powers off. Before maintaining the equipment, check that no hazardous voltages remain in the DC bus or components to be maintained by using a multimeter.
-

ffi CAUTION

- Do not connect two or more cables to the positive or negative power port of a battery in parallel.
 - Stay away from the equipment when preparing cables to prevent cable scraps from entering the equipment. Cable scraps may cause sparks and result in personal injury and equipment damage.
-

8.1 System Power-Off

Precautions

& WARNING

- After the system powers off, the remaining electricity and heat may still cause electric shocks and body burns. Therefore, wear protective gloves 5 minutes after the system is powered off before performing any operation on the battery. You can maintain the battery only when all indicators on the battery are off.
 - When the ESS is running, you can only turn off the DC switch of the battery, but cannot power off the ESS completely. In this case, you cannot maintain the battery.
-

Powering Off the System

- Step 1** Turn off the AC switch between the inverter and the power grid.
- Step 2** Turn off the DC switch at the bottom of the inverter.
- Step 3** Turn off the DC switch between the PV string and the inverter if there is any.
- Step 4** Turn off the DC switch on the battery.

----End

8.2 Routine Maintenance

To ensure that the battery can operate properly for a long term, you are advised to perform routine maintenance on it as described in this chapter.

& CAUTION

Before cleaning the system, connecting cables, and ensuring the grounding reliability, power off the system.

Table 8-1 Maintenance checklist

Check Item	Check Method	Maintenance Interval
System cleanliness	Check periodically that the heat sinks are free from obstacles and dust.	Once every 6 to 12 months

Check Item	Check Method	Maintenance Interval
System running status	<ul style="list-style-type: none"> • Check that the battery is not damaged or deformed. • Check that the battery does not generate abnormal sound when it is in operation. • Check that the battery parameters are correctly set when the battery is running. 	Once every 6 months
Electrical Connection	<ul style="list-style-type: none"> • Check that cables are secured. • Check that cables are intact, and that in particular, the parts touching the metallic surface are not scratched. • Check that unused DC input terminals, battery terminals, and COM ports are locked by watertight caps. 	The first inspection is 6 months after the initial commissioning. From then on, the interval can be 6 to 12 months.
Grounding reliability	Check that ground cables are securely connected.	The first inspection is 6 months after the initial commissioning. From then on, the interval can be 6 to 12 months.

8.3 Troubleshooting

Alarm severities are defined as follows:

- Major: The battery shuts down or some functions are abnormal due to a fault.
- Minor: Some components of the battery are faulty but the battery can still work.

Table 8-2 Common alarms and troubleshooting measures

Alarm ID	Alarm Name	Alarm Severity	Possible Cause	Troubleshooting
3000	Low battery DC input bus voltage	Major	<ol style="list-style-type: none"> 1. The DC bus voltage of the battery is low. 2. The battery DC switch is OFF. 3. The battery cables are not correctly connected. 	<ol style="list-style-type: none"> 1. Turn off the inverter AC output switch, inverter DC input switch, and battery DC switch, and wait for 5 minutes. 2. Check the cable connections to the [Battery-1/2] power control module by referring to the quick installation guide. 3. After checking that the battery power cables are correctly connected, turn on the battery DC switch, AC output switch, and inverter DC input switch in sequence. 4. If the alarm persists, contact your dealer or Svea Solar technical support.
3001	Abnormal battery power control module	Major	A major fault has occurred on the internal circuit of the battery power control module.	<ol style="list-style-type: none"> 1. Turn off the inverter AC output switch, inverter DC input switch, and battery DC switch, and wait for 5 minutes. 2. Turn on the battery DC switch, inverter AC output switch, and DC input switch. 3. If the alarm persists on the [Battery-1/2] power control module (the battery fault indicator is steady on), contact your dealer or Svea Solar technical support.

Alarm ID	Alarm Name	Alarm Severity	Possible Cause	Troubleshooting
3002	Battery power control module overtemperature	Minor	<ol style="list-style-type: none"> 1. The installation position of the battery power control module is not well ventilated. 2. The ambient temperature is excessively high. 3. The battery power control module is abnormal. 	<ol style="list-style-type: none"> 1. Check the ventilation and whether the ambient temperature of the [Battery-1/2] power control module exceeds the upper threshold. 2. If the ventilation is poor or the ambient temperature is excessively high, improve the ventilation and heat dissipation. 3. If the ventilation and ambient temperature are normal, contact your dealer or Svea Solar technical support.
3003	Battery power control module fuse blown	Major	The fuse of the battery power control module is blown.	<ol style="list-style-type: none"> 1. Turn off the inverter AC output switch, inverter DC input switch, and battery DC switch, and wait for 5 minutes. 2. Replace the fuse of the [Battery-1/2] power control module. 3. Turn on the battery DC switch, inverter AC output switch, and inverter DC input switch in sequence. If the alarm persists, contact your dealer or Svea Solar technical support.

Alarm ID	Alarm Name	Alarm Severity	Possible Cause	Troubleshooting
3004	Battery power control module reversely connected	Major	The positive and negative terminals are reversely connected when the battery power control module connects to the inverter.	<ol style="list-style-type: none">1. Turn off the inverter AC output switch, inverter DC input switch, and battery DC switch, and wait for 5 minutes.2. Check the cable connections to the [Battery-1/2] power control module by referring to the quick installation guide.3. After checking that the battery power cables are correctly connected, turn on the battery DC switch, AC output switch, and inverter DC input switch in sequence.4. If the alarm persists, contact your dealer or Svea Solar technical support.

Alarm ID	Alarm Name	Alarm Severity	Possible Cause	Troubleshooting
3005	Battery power control module DC switch OFF	Warning	<ol style="list-style-type: none">1. The DC switch of the battery power control module is OFF.2. The DC bus cable to the battery power control module is disconnected.	<ol style="list-style-type: none">1. Turn off the inverter AC output switch, inverter DC input switch, and battery DC switch, and wait for 5 minutes.2. Check the cable connections to the [Battery-1/2] power control module by referring to the quick guide.3. After checking that the battery power cables are correctly connected, turn on the battery DC switch, AC output switch, and inverter DC input switch in sequence.4. If the alarm persists, contact your dealer or Svea Solar technical support.

Alarm ID	Alarm Name	Alarm Severity	Possible Cause	Troubleshooting
3006	Abnormal battery expansion module	Major	A major fault has occurred on the internal circuit of the battery expansion module.	<ol style="list-style-type: none">1. Check that the power cables and communications cables are correctly connected to the [Battery-1/2 battery expansion module-1/2/3] battery expansion modules.2. Send a shutdown command on the app, turn off the inverter AC output switch, inverter DC input switch, and battery DC switch, and wait for 5 minutes.3. Turn on the battery DC switch, inverter AC output switch, and DC input switch.4. If the alarm persists, contact your dealer or Svea Solar technical support.

Alarm ID	Alarm Name	Alarm Severity	Possible Cause	Troubleshooting
3007	Battery expansion module cable disconnected	Major	<ol style="list-style-type: none"> 1. A battery expansion module cable is disconnected. 2. A battery expansion module is abnormal. 	<ol style="list-style-type: none"> 1. Turn off the inverter AC output switch, inverter DC input switch, and battery DC switch, and wait for 5 minutes. 2. Check whether the power cable is securely connected to the [Battery-1/2 battery expansion module-1/2/3] battery expansion modules (the terminal is loose or disconnected, or the cable is disconnected). For details, see the quick installation guide. 3. After checking that the cables are correctly connected, turn on the battery DC switch, AC output switch, and inverter DC input switch in sequence. 4. If the alarm persists, contact your dealer or Svea Solar technical support.

Alarm ID	Alarm Name	Alarm Severity	Possible Cause	Troubleshooting
3008	Battery expansion module overtemperature	Minor	<ol style="list-style-type: none"> 1. The battery installation position is not well ventilated. 2. The ambient temperature is excessively high. 3. The battery power control module is abnormal. 	<ol style="list-style-type: none"> 1. Check the ventilation and whether the ambient temperature of the [Battery-1/2 battery expansion module-1/2/3] battery expansion modules exceeds the upper threshold. 2. If the ventilation is poor or the ambient temperature is excessively high, improve the ventilation and heat dissipation. 3. If the ventilation and ambient temperature are normal, contact your dealer or Svea Solar technical support.
3009	Battery expansion module low temperature	Minor	<ol style="list-style-type: none"> 1. The ambient temperature is excessively low. 2. A battery expansion module is abnormal. 	<ol style="list-style-type: none"> 1. Check whether the ambient temperature in the installation positions of the [Battery-1/2 battery expansion module-1/2/3] battery expansion modules is lower than the lower threshold. 2. If the ambient temperature is excessively low, improve the installation environment. 3. If the alarm persists after the ambient temperature becomes normal, contact your dealer or Svea Solar technical support.

Alarm ID	Alarm Name	Alarm Severity	Possible Cause	Troubleshooting
3010	Battery expansion module short circuit	Major	<ol style="list-style-type: none"> 1. The battery expansion module is short-circuited. 2. A battery expansion module is abnormal. 	<ol style="list-style-type: none"> 1. Turn off the inverter AC output switch, inverter DC input switch, and battery DC switch, and wait for 5 minutes. 2. Check the power cable connection to the [Battery-1/2 battery expansion module-1/2/3] battery expansion modules by referring to the quick installation guide. If the cable is damaged or short-circuited, replace it. 3. After checking that the cables are correctly connected, turn on the battery DC switch, AC output switch, and inverter DC input switch in sequence. 4. If the alarm persists, contact your dealer or Svea Solar technical support.
3011	Battery expansion module undervoltage	Warning	The voltage of a battery expansion module is low.	If the sunlight is sufficient or AC reverse charging is allowed, the [Battery-1/2 battery expansion module-1/2/3] battery expansion modules can be charged when the inverter is running.

Alarm ID	Alarm Name	Alarm Severity	Possible Cause	Troubleshooting
3012	Abnormal battery power control module parallel communication	Major	The battery power control modules of the parallel system fail to communicate with each other.	<ol style="list-style-type: none"> 1. Send a shutdown command on the app, turn off the inverter AC output switch, inverter DC input switch, and battery DC switch, and wait for 5 minutes. 2. Check that the communications cable is correctly connected between the [Battery-1/2] battery power control modules of the parallel system. 3. After checking that the cables are correctly connected, turn on the battery DC switch, AC output switch, and inverter DC input switch in sequence. 4. If the alarm persists, contact your dealer or Svea Solar technical support.
3013	Abnormal battery expansion module communication	Major	The battery power control module fails to communicate with the battery expansion modules.	<ol style="list-style-type: none"> 1. Turn off the battery DC switch. 2. Check that the power cables and communications cables are correctly connected to the [Battery-1/2 battery expansion module-1/2/3] battery expansion modules. 3. After checking that cables are correctly connected, turn on the battery DC switch. 4. If the alarm persists, contact your dealer or Svea Solar technical support.

Alarm ID	Alarm Name	Alarm Severity	Possible Cause	Troubleshooting
3047	Battery Pack Undervoltage	Major	<ol style="list-style-type: none"> 1. The voltage of the battery pack or its cell is too low. 2. The battery pack has been stored for a long period of time. 3. The battery pack has been idle for a long time after grid connection. 	<ol style="list-style-type: none"> 1. The 3047-1 (battery pack undervoltage protection) and 3047-2 (cell undervoltage protection) alarms do not affect the running of other battery packs. 2. Connect to the power grid and charge batteries in a timely manner. 3. If the alarm persists after the battery has been charged for one hour, contact your dealer or technical support.
3049	Inconsistent Battery Power Control Module Versions	Warning	<ol style="list-style-type: none"> 1. The versions of the power control modules in the parallel system are inconsistent. 2. The update failed. 	<ol style="list-style-type: none"> 1. The version of the power control modules in [Battery-CabinetNo] is inconsistent with that of other power control modules in the parallel system and needs to be updated. 2. If the update fails multiple times, contact your dealer or technical support.
3050	Inconsistent ESS Versions	Warning	<ol style="list-style-type: none"> 1. The version of the battery power control modules is inconsistent with that of the battery packs. 2. The update failed. 	<ol style="list-style-type: none"> 1. The version of the power control modules in [Battery-CabinetNo] is inconsistent with that of the battery packs and needs to be updated. 2. If the update fails multiple times, contact your dealer or technical support.

Alarm ID	Alarm Name	Alarm Severity	Possible Cause	Troubleshooting
3051	ESS Version Mismatch	Major	1. The version of the battery power control modules does not match that of the battery packs, which affects the normal operation. 2. The update failed.	1. The version of the power control modules in [Battery-CabinetNo] does not match that of the battery packs and needs to be updated. 2. If the update fails multiple times, contact your dealer or technical support.
3061	Battery Pack Lifespan Reached	Major	The battery has reached its lifespan.	The battery has reached the end of its lifespan. Contact the local recycling agency to dispose of it in compliance with local laws and regulations as well as applicable standards.

8.4 Battery Storage and Recharge

Battery Acceptance Inspection

A battery recharge label must be put on the battery packing case. The recharge label should contain the latest charge time and the next recharge time.

Battery Storage Requirements

1. Place batteries according to the signs on the packing case during storage. Do not put batteries upside down or sidelong.
2. Stack battery packing cases by complying with the stacking requirements on the external package.
3. Handle batteries with caution to avoid damage.
4. The storage environment requirements are as follows:
 - Ambient temperature: -10-55°(; recommended storage temperature: 20-30°(
 - Relative humidity: 5% to 80%
 - Place batteries in a dry and clean place with proper ventilation.
 - Place batteries in a place that is away from corrosive organic solvents and gases.
 - Keep batteries away from direct sunlight.

Keep batteries at least 2 meters away from heat sources.

5. The batteries in storage must be disconnected from external devices. The indicators (if any) on the batteries should be off.
6. AC mains input voltage requirements in the recharge places: single-phase power grid: 220 V/230 V/240 V, $\pm 10\%$; three-phase voltage: 380 V/400 V, $\pm 10\%$.
7. The warehouse keeper should collect battery storage information every month and periodically report the battery inventory information to the planning department. The batteries that have been stored for nearly 15 months (-10 - 25°C), 9 months (25 - 35°C) or 6 months (35 - 55°C) should be recharged in a timely manner
8. Batteries should be delivered based on the "first in, first out" rule.
9. After the battery production test is complete and before the batteries are stored, the batteries must be recharged to at least 50% of the SOC.

Conditions for Judging Overdue Storage

It is recommended that batteries not be stored for a long period. They should be used soon after being deployed onsite. The batteries should be handled according to the following requirements.

Table 8-3 Lithium battery recharge interval

Required Storage Temperature	Actual Storage Temperature	Recharge Interval	Remarks
$-10^{\circ}\text{C} < T \leq 55^{\circ}\text{C}$	$T \leq -10^{\circ}\text{C}$	Not allowed	Not reaching the time for recharge: Use the batteries as soon as possible. Reaching the time for recharge: Recharge the batteries. The total storage duration should not exceed the warranty period.
	$-10^{\circ}\text{C} < T \leq +25^{\circ}\text{C}$	15 months	
	$25^{\circ}\text{C} < T \leq 35^{\circ}\text{C}$	9 months	
	$35^{\circ}\text{C} < T \leq 55^{\circ}\text{C}$	6 months	
	$55^{\circ}\text{C} < T$	Not allowed	

1. Dispose of deformed, damaged, or leaking batteries directly irrespective of how long they have been stored.
2. The storage duration starts from the latest charge time labeled on the battery package. If a battery is qualified after recharge, update the latest charge time and the next recharge time (next recharge time = latest charge time + recharge interval) on the label.
3. The maximum power storage period of a lithium battery is three years. A lithium battery can be recharged at most for three times within the three

years. For example, it can be recharged every 8 months or every 12 months. It is recommended that batteries be scrapped if the maximum allowable storage period and recharging times are exceeded.

- If a lithium battery is stored for a long time, capacity loss may occur. After a lithium battery is stored for 12 months in the recommended storage temperature, the irreversible capacity loss rate is 3%-10%. If customers perform the discharge test according to the specifications, they may fail to pass the test if the storage capacity of the battery is not 100% of the rated capacity.

Inspection Before Recharge

- Before recharging a battery, you need to check its appearance. Recharge the battery if it is qualified or dispose of it if not.
- The battery is qualified if it is free from the following symptoms:
 - Deformation
 - Shell damage
 - Leakage

Battery Recharging Scenarios

Three-Phase Power Supply Scenario

- The 10kW Power Shifter inverter provides 10 kW power to charge batteries. It allows two charge units (six battery packs) to be charged at the same time. Other models can charge batteries with a power of less than 10 kW.

Figure 8-1 Networking diagram for three-phase power supply scenario

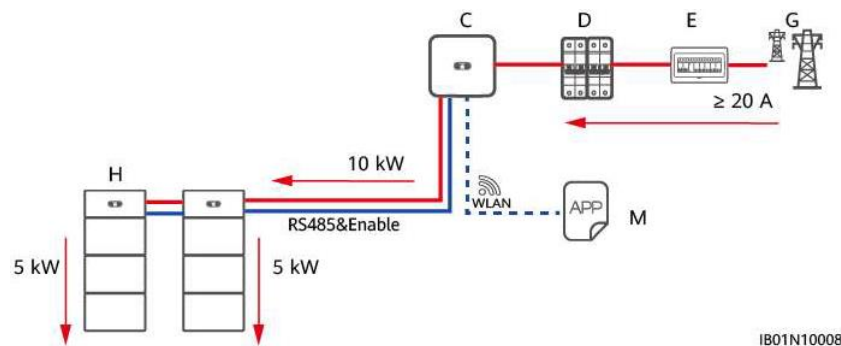

(C) 10kW Power Shifter

(D) AC switch

(E) ACDCU

(G) Power grid

(H) Power Saver

(M) FusionSolar app

[D] NOTE

— indicates a power cable, — indicates a signal cable, - - - - - indicates wireless communication.

Battery Recharging Cable Connection

Lt_ WARNING

Use standard cables provided by Svea Solar to connect the power control module and battery expansion modules. Do not use non-standard cables (such as extension cables and interconnection cables). If B+ or B- battery cables are reversely connected, the device will be damaged.

Connect cables by referring to [6 Electrical Connection](#). If two charge units need to be charged at the same time, cascade the batteries by referring to [6.4 \(Optional\) Cascading Batteries](#).

Figure 8-3 Cable connection diagram

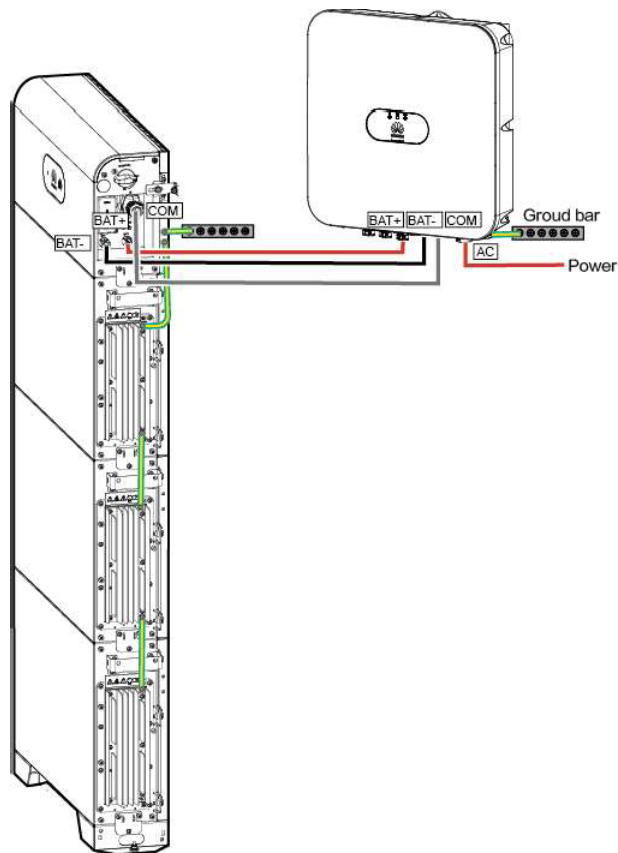

Battery Power-On and Commissioning

NOTICE

- Ensure that the charge process is supervised to prevent any abnormality.
- If a battery experiences an abnormality such as bulging or smoking, stop charging immediately and dispose of it.
- Ensure that only trained professionals perform recharge operations.
- After turning on the battery switch, power on the inverter. For details about how to power on the inverter, see the quick guide for the corresponding inverter model.
- When the battery SOC is 0%, the battery cannot be activated by holding the black start button. The battery can be started only after both the DC and AC power supplies are connected.
- It is recommended that the battery be charged to 50% SOC. Long-term storage will cause capacity loss, after a lithium battery is stored for 12 months in the recommended storage temperature, the irreversible capacity loss rate is 3%-10%.

Step 1 Connect power cables and communications cables correctly.

- Step 2** Turn on the battery power pack switch by turning the DC switch to ON.
- Step 3** Turn on the AC switch between the inverter and the grid.
- Step 4** Check that LED2 is steady green, and LED3 is blinking green slowly.
- Step 5** Hold down the black start button for Ss to activate the battery. The power control module LED blinks three times and then the green indicator is steady on. The battery comprehensive LED blinks three times and then the green indicator is steady on. The ring LED blinks three circles.
- Step 6** Connect the FusionSolar app to the inverter, the operation procedure will be updated later.
- Step 7** Confirm that the recharge is complete if five indicators of the ring LED are on and the comprehensive LED of the battery expansion modules is steady green.
- Step 8** After the battery is charged, switch off the inverter input AC circuit breaker and then the battery input circuit breaker. If other batteries need to be charged, repeat the preceding steps.

---End

8.5 Recharge Requirements for Batteries with a Low SOC

After the ESS is powered off, static power consumption and self-discharge loss may occur in battery modules. Therefore, charge battery modules in a timely manner and do not store the ESS in low state of charge (SOC). Otherwise, the ESS may be damaged due to overdischarge, and battery modules need to be replaced.

Storing the ESS with low SOC may occur in the following scenarios:

- DC SWITCH on the power control module is OFF.
- The ESS power cables or signal cables are not connected.
- The ESS cannot be charged due to a system fault after discharge.
- The ESS cannot be charged due to incorrect configurations in the system.
- The ESS cannot be charged due to no PV input and long-term mains failure.

Regardless of scenarios, the ESS must be charged within the maximum interval corresponding to the SOC when the ESS is powered off. If the ESS is not charged beyond the maximum interval, it may be damaged due to overdischarge.

Power-Off SOC Before Storage	Maximum Charge Interval
SOC 5%	30 days
0%:;;; SOC< 5%	7 days

NOTE

- When the SOC of the ESS decreases to 0%, charge the ESS within seven days. Any permanent battery damage due to customer's failure to charge the ESS properly is not covered under warranty.
- When the SOC of the ESS is low due to self-discharge loss or extended periods of storage without being charged, the system forcibly charges the ESS to prevent damage from overdischarge. Additionally, in situations where the PV power is insufficient, the system will draw power from the power grid regardless of the **Charge from AC** threshold.

8.6 Battery SOH Check

- To ensure safe and reliable operation of the ESS, the system checks and calibrates the state of health (SOH) of batteries. If the SOH is low, safety risks may exist. In this case, the ESS stops working and generates an alarm. During battery operation, if the SOH calculation conditions are met, the SOH is calibrated naturally. If the SOH calculation conditions are not met, the SOH value may be inaccurate. In this case, force SOH calibration is required to accurately calculate the SOH value.
- Natural SOH calibration: When batteries are fully charged during normal operation and discharge to about 5% to 10% state of charge (SOC) and the batteries are not charged during the discharge, the SOH value is calculated during this process, which is equivalent to a natural calibration.

For example, when the ESS works in the maximum self-consumption mode, if the PV power is greater than the load power, the surplus PV power fully charges the battery to 100% SOC. If the PV power is insufficient, the batteries discharge to 5% SOC. This process is equivalent to a natural calibration during battery operation.

- Force SOH calibration: In normal operation, force SOH calibration is performed one year after the last SOH calibration (natural or force calibration). It is also performed one month after the last SOH calibration (natural or force calibration) near the end of the battery service life.

Impact of SOH Calibration

- SOH natural calibration: Natural calibration occurs when batteries are running properly and does not affect the operating status of the ESS.
- When batteries are in the force SOH calibration state, check that **SOH Calibration Status** is **Calibrating...** in the ESS information by referring to section [6.3.3 Querying the Battery Status](#).
- Force SOH calibration: During force SOH calibration, the batteries are charged to 100% SOC, and then immediately discharge to 0% SOC. Charging is not allowed during the discharging process. To ensure accurate calculation, the discharging process needs to be completed within 24 hours. In this case, you can increase the load power to shorten the calibration time. If the discharge time limit is exceeded, the calibration will fail. After the failure, the calibration will be started again 48 hours later. Force SOH calibration is performed on a single battery pack. Only one battery pack can be calibrated under a single inverter at a time. Battery packs under multiple inverters can be calibrated at the same time. During force SOH calibration, the working mode of the ESS will be changed. For details, see the following table.

Table 8-4 Impact of force SOH calibration

ESS Working Mode	Current Charge/ Discharge Status	SOH Calibration's Impact on Charging	SOH Calibration's Impact on Discharging
TOU	Charging	The ESS working mode is not affected. Batteries are charging at the maximum power.	Batteries are discharging at the current load power (the discharged battery energy cannot be fed to the grid). 1. When the battery discharge power is greater than the load power, the battery discharges and the surplus PV power cannot be fed to the grid. The inverter power is limited, affecting the energy yield. 2. If the battery discharge power is less than the load power, the PV power is supplied to loads at the same time.
	Discharging	Batteries stop discharging and are charging at the maximum power.	
Max. self-consumption	The PV power is greater than the load power and battery charge power, and the surplus PV power is fed to the grid.	The ESS working mode is not affected. Batteries are charging at the maximum power.	The inverter power is limited, affecting the energy yield. 2. If the battery discharge power is less than the load power, the PV power is supplied to loads at the same time.
	The PV power is greater than the load power, and batteries are charging.	Batteries are charging at the maximum power. Power from the grid may be supplied to loads.	
	The PV power is less than the load power, and batteries are discharging.	Batteries stop discharging and are charging at the maximum power. More power from the grid is supplied to loads.	
Fully fed to grid	The PV power is greater than the power limit at the grid-connection point, and batteries are charging.	The battery is charging at the maximum power, and the feed-in power decreases.	Batteries are discharging at the maximum power, and the total power of PV and batteries is less than the power limit at the grid-connection point. In the daytime, the PV power fully charges the batteries. At night, the

ESS Working Mode	Current Charge/ Discharge Status	SOH Calibration's Impact on Charging	SOH Calibration's Impact on Discharging
	The PV power is less than the power limit at the grid-connection point, and batteries are discharging.	Batteries stop discharging and are charging at the maximum power. The feed-in power decreases.	batteries discharge to less than 5% SOC, which basically meets the natural calibration conditions. Therefore, the force SOH calibration is rarely started.

NOTE

- When the ESS runs in the pure off-grid mode or without the PV system, SOH calibration is not supported.
- When the grid power fails, force SOH calibration exits during off-grid switching. If the SOC is lower than the backup SOC during switching, backup power is affected.
- If Charge from grid is enabled during SOH calibration, the ESS may obtain power from the grid to fully charge batteries quickly.
- If the ESS or inverter is powered off during SOH calibration, the calibration fails and the system does not save the calibration process data. After power-on, the calibration restarts when the SOH calibration conditions are met.

9 Emergency Handling

If an accident (including but not limited to the following) occurs on the site, ensure the safety of onsite personnel first and contact the Company's service engineers.

Battery Falling or Strong Impact

DANGER

If a battery is dropped or violently impacted during installation, it may become faulty and cannot be used. Using a faulty battery will cause safety risks such as cell leakage and electric shock.

- If a battery has obvious damage or abnormal odor, smoke, or fire occurs, evacuate the personnel immediately, call emergency services, and contact the professionals. The professionals can use fire extinguishing facilities to extinguish the fire under safety protection.
- If the appearance is not deformed or damaged, and there is no obvious abnormal odor, smoke, or fire, contact the professionals to transfer the battery to an open and safe place, or contact a recycling company for disposal.

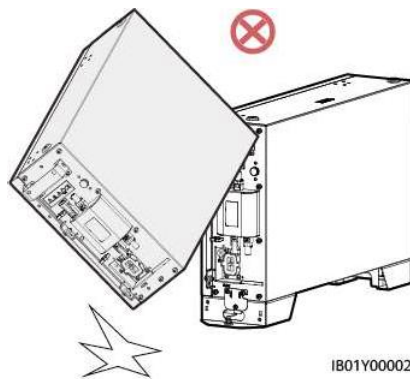

Flood

- Power off the system if it is safe to do so.
- If any part of the batteries is submerged in water, do not touch the batteries to avoid electric shock.
- Do not use batteries that have been soaked in water. Contact a battery recycling company for disposal.

Smoke or Fire

DANGER

- In case of smoke or fire, if there is a large amount of smoke in the battery storage room, do not open the door to prevent explosion risks and toxic gas inhalation.
- If a lithium battery catches fire, flammable and toxic gases will be released. Therefore, during the extinguishing process, all firefighters must wear a full set of protective suite, including flame retardant/fireproof clothing, air-purifying respirator or breathing apparatus, firefighter helmet and mask, and insulated shoes.
- A lithium battery fire may last for several hours. After it is extinguished, the fire may be reignited by the heat generated from residual ingredients due to internal cell damage. After an open flame is extinguished, continue spraying water to cool the batteries. Wait until the battery temperature drops to the room temperature $\pm 10^{\circ}\text{C}$ and monitor for 24 hours to ensure that there is no sign of temperature rise before removing the batteries. Move the removed batteries to a safe place (an open and safe outdoor place is recommended), and then place the batteries in the fire sand box or salt water.

If a Power Saver ESS emits smoke or catches fire, household members should not dispose of the ESS by themselves. Follow the processes in the flowchart below.

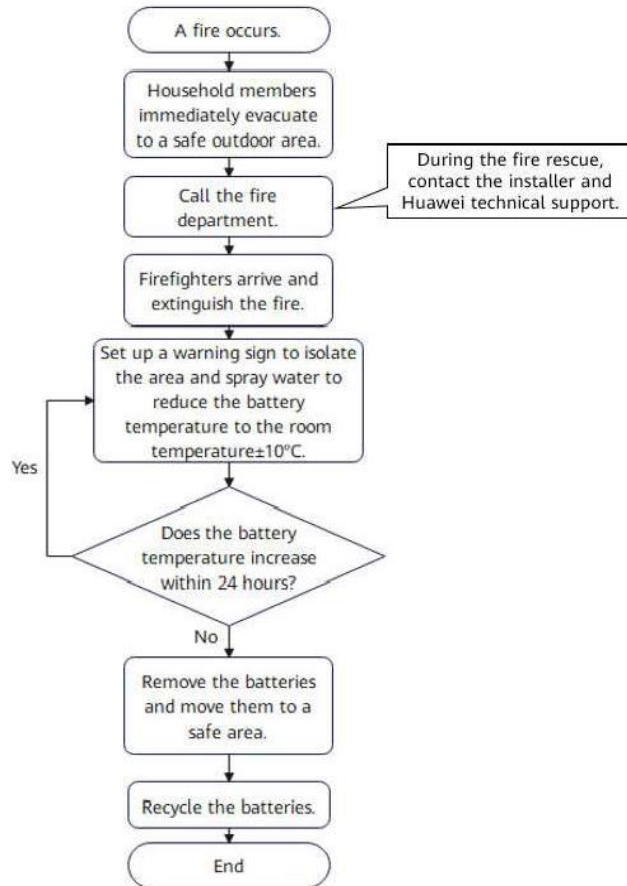

The detailed description is as follows:

1. If batteries emit smoke or catch fires, notify all household members to evacuate immediately.
2. After evacuating to a safe outdoor area (20 m away is recommended), call the fire department immediately. While waiting for the fire rescue, contact the installer and Svea Solar technical support.
3. Firefighters arrive at the site and extinguish the fire.
4. After the fire is extinguished, set up a warning sign to isolate the area and spray water to reduce the battery temperature to the room temperature $\pm 10^{\circ}\text{C}$. (You can use an infrared thermometer or thermal imager.)
5. Observe the batteries for 24 hours and ensure that there is no sign of temperature rise before removing the batteries. (Only professionals are allowed to remove the batteries.)
6. After removing the batteries, move them to a safe place (an open and safe outdoor place is recommended), place them in the fire sand box or salt water. These operations must be performed by professionals who must take insulation measures, such as wearing insulated gloves, insulated shoes, and personal protective equipment (PPE).

7. After the battery fire is extinguished, if there is no potential risk onsite, the battery must be handled and recycled by professionals in accordance with local laws and regulations.

Electric Shock

ffi DANGER

Before the injured person is separated from the source of electricity, onsite paramedic personnel are not allowed to touch the injured person with their hands to avoid electric shocks.

ffi WARNING

Even if the AC circuit breaker of an inverter is turned off, PV modules and the DC side of the inverter are still energized in the daytime.

For household members, if an electric shock occurs related to a PV device, you are advised to follow the following steps:

- (1) Turn off the AC circuit breaker of the inverter.
- (2) Wear dedicated insulated shoes and insulated gloves, and use insulated tools to separate the injured person from the source of electricity. If no professional equipment is available, you can step on a dry wooden stool or hold insulated tools (such as a long dry wooden stick) to separate the injured person from the source of electricity while ensuring your safety.
- (3) If the injury is serious, call the emergency medical service immediately. Let the injured person lie flat and monitor the person's consciousness, breathing, and heartbeat changes. Personnel who have first aid qualifications or have received first aid training can perform first aid such as artificial respiration and cardiopulmonary resuscitation based on the situation of the injury onsite until the paramedic personnel arrive to send the injured person to the hospital.
- (4) Install warning objects and barricades around the electric shock site to prevent other personnel from getting electric shocks.
- (5) Notify distributors and installers to dispatch professional O&M personnel to rectify the fault.

Battery Leakage

Lt DANGER

- The leaked electrolyte is a colorless viscous liquid that may evaporate rapidly and is flammable, turning into white salt residues. The electrolyte has a pungent smell and is corrosive, irritating to eyes and skin. Avoid contact with it.
- When handling chemical leakage incidents, professional maintenance personnel and firefighters must wear necessary protective equipment such as air-purifying respirator and other PPE.

For household members, if battery leakage occurs, you are advised to follow the following steps:

(1) Stop the ESS immediately and set the battery power control module (DCDC) switch to OFF. Turn off the AC circuit breaker of the inverter and set the inverter DC switch to OFF.

(2) Indoor installation scenario: Indoor personnel should quickly evacuate, open the doors, windows, and ventilation devices of the room, and turn off indoor fire sources during the evacuation. Outdoor installation scenario: Notify outdoor personnel to stay away from the site and set up a warning sign to isolate the area.

(3) After evacuating to a safe area, notify professional maintenance personnel or firefighters to handle the emergency.

Avoid contact with electrolytes or released gases. In the case of contact, take the following measures:

- Inhalation: Evacuate from contaminated areas, get fresh air immediately, and seek immediate medical attention.
- Eye contact: Immediately wash your eyes with water for at least 15 minutes, do not rub your eyes, and seek immediate medical attention.
- Skin contact: Wash the affected areas immediately with soap and water and seek immediate medical attention.
- Intake: Seek immediate medical attention.

Conclusion and Follow-Up Procedure

- After a battery fire is extinguished and there is no potential risk onsite, professionals handle and recycle the batteries after wearing insulated gloves, insulated shoes, and other PPE in accordance with local laws and regulations. After an accident occurs, the manufacturer can identify the damage to the device and replace the device according to the corresponding procedure to restore the ESS.
- After a battery fire is extinguished, the fire extinguishing water may pollute the surrounding soil and water source. In this case, notify the related environmental protection department for evaluation and handling.
- If you have any questions about Svea Solar residential inverters and ESSs, contact the installer.

10 Technical Specifications

10.1 PowerSaver-SKW-CO

Technical Specifications	I Power Saver-SKW-CO
Rated charge and discharge power	5 kW
Nominal voltage (single-phase system)	450 V
Operating voltage (single-phase system)	350–560 V
Nominal voltage (three-phase system)	600 V
Operating voltage (three-phase system)	600–980 V
Dimensions (H x W x D)	240 mm x 670 mm x 150 mm
Weight	12 kg
Cooling mode	Free cooling
IP rating	IP66
Communications	RS485 and CAN (for cascading)
Operating temperature	-25°C to +55°C
Operating humidity	5%-95% RH
Maximum operating altitude	4000 m

10.2 Power Saver-5-E0

Technical Specifications	Power Saver-5-E0
Nominal available capacity ^a	5 kWh
Battery cell type	Li-ion
Dimensions (H x W x D)	360 mm x 670 mm x 150 mm
Weight	50 kg
Cooling mode	Free cooling
IP rating	IP66
Operating temperature	-20°(to +55°(
Maximum operating altitude	4000 m
<p>Note a: The initial capacity (design capacity) of the battery modules is 5 kWh. The actual capacity may vary depending on the environment conditions, such as temperature, transportation conditions, and storage conditions.</p>	

10.3 SUN2000-Related

Table 10-2 Power Shifter 6/8/10kW models

Parameter				Power Shifter 6kW model	Power Shifter 8kW model	Power Shifter 10kW model
Off-grid power				3300 W	3300 W	3300 W
Charging power from grid to inverter				6000 W	8000 W	10000 W
Battery port power				10000 W	10000 W	10000 W

11 FAQs

11.1 How Do I Replace a Fuse?

Replacement background: When the inverter is faulty, the Battery fuse is likely to be damaged. In this case, check whether the fuse is open-circuited and replace it.

Step 1 Power off the system. For details, see [8.1 System Power-Off](#).

Lt WARNING

After the system is powered off, the remaining electricity and heat still exist in the chassis, which may cause electric shocks or burns. Therefore, you need to wear protective gloves and perform operations 5 minutes after the system is powered off.

Step 2 Loosen the screws on the fuse shell.

Figure 11-1 Removing the screw shell

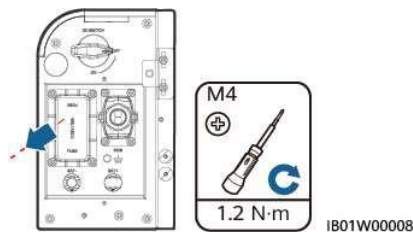

Step 3 Lift the fuse box opening, remove the fuse, insert a new fuse into the slot, and close the fuse box. If you hear a click sound and the bulge on the side is inside the box, the fuse box is properly installed.

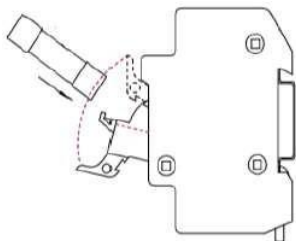
Figure 11-2 Replacing a fuse

---End

Fuse Specifications

Table 11-1 Fuse specifications

Fuse	Required Specifications		
	Lower Limit	Typical Value	Upper Limit
Type		Fuse	
Component type		Fast blow fuse	
Rated voltage (V AC&V DC)	1100 V DC	-	-
Rated current	32A		
Breaking capacity	10 kA		
Nominal fusing heat I ² T	600	-	1000
Cold resistance value	-	-	0.005 Ω
Package dimensions (the dimension tolerance should be specified in the specifications provided by the supplier)	-	14 mm x 51 mm	-

Table 11-2 Fuse model

Number	Fuse model	Manufacture
	FWL-32A14F	Cooper Xi'an Fusegear Co., Ltd
2	VC14-32A110 0VDCAR	VICFUSE
3	RS309- MM-14C32A	Xi'an Sinofuse Electric Co., Ltd

11.2 SOC Change Description

1. How does the SOC change from 99% to 100% when the battery is about to be fully charged?

When the SOC is greater than 99%, the battery switches to float charging and the charging current decreases gradually. Finally, the SOC reaches 100%.

2. When the battery temperature is low, the charging power is displayed as about 300 W, but the SOC does not change. Why?

When the internal temperature of the battery module is low, the internal heating component starts to heat the battery. The heating power is 300 W (typical value). When the heating component is working, the battery is not charged and the SOC does not change. Battery heating helps to keep the cell at a proper operating temperature and prolong the service life of the product.

11.3 Checking Cable Connection when the Battery Fails to Be Upgraded

If the battery fails to be upgraded, check the cable connections by referring to [6 Electrical Connection](#). If the upgrade fails, reconnect the cables correctly and perform the upgrade again.

11.4 Delayed Upgrade Description

After logging in to the inverter, if the FusionSolar app detects that the Power Saver firmware version is outdated, the app prompts you to upgrade the Power Saver. You can choose immediate activation or delayed activation. If you choose immediate activation, the LUNA will be upgraded immediately after the firmware package is uploaded. The upgrade process takes approximately 30 minutes. If you choose delayed activation, the activation of the firmware will be performed four hours after you log out of the app.

11.5 How Do I Recycle Used Batteries?

NOTICE

- The Company does not recycle batteries. Contact local recycling agencies to handle batteries.
 - If there are no such agencies in your area, you can contact the nearest foreign recycling agencies.
-

Step 1 Contact the nearest recycling agency.

Step 2 Recycling agencies assess the costs.

Step 3 Recycling agencies carry out recycling, which can be done in two ways:

- Onsite recycling: Recycling agencies can visit your sites to recycle lithium batteries, but the price depends on actual conditions such as the distance and transportation expenses.
- Centralized recycling: You can collect all lithium batteries to be recycled in one place for the recycling agencies to handle.

NOTE

You need to cover the related transportation expenses.

Step 4 Recycling companies handle recycling. The recycled lithium batteries are at the disposal of the recycling companies.

---End

A Acronyms and Abbreviations

A	
APP	application
B	
BMS	battery management system
D	
DC	direct current
F	
FIT	feed-in tariff
E	
EMI	electromagnetic interference
p	
PV	photovoltaic
V	
VPP	virtual power plant